

PARTIAL GROUND FLOOR PLAN

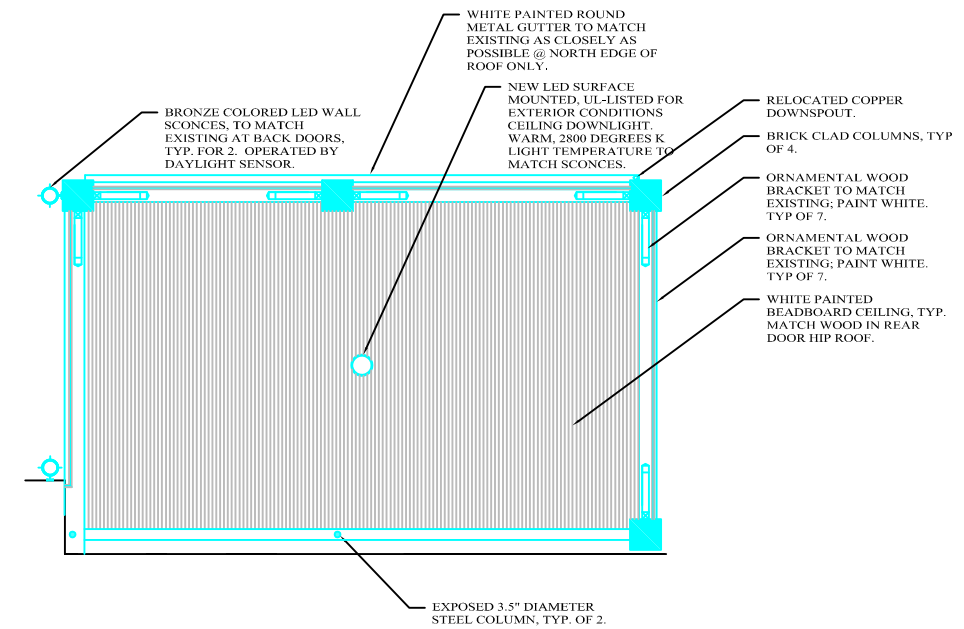

REFLECTED CEILING PLAN

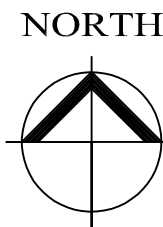
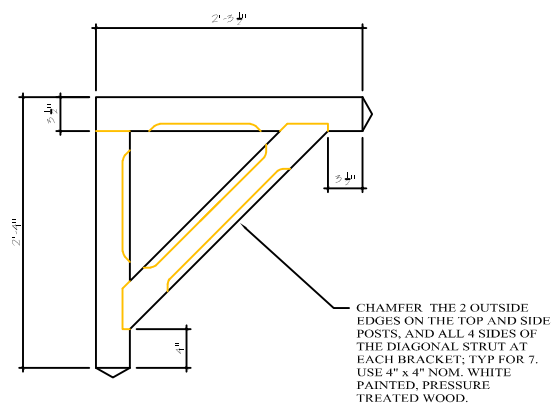

BRACKET DETAILS

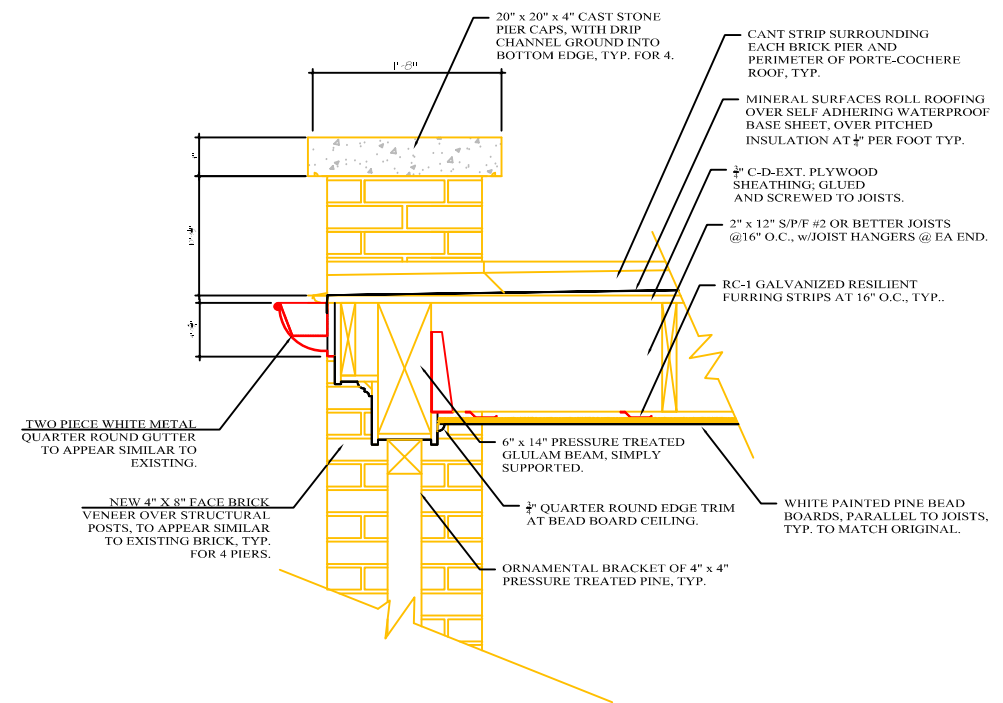

ROOF EDGE DETAIL

**NEW PORTE-COCHERE AT
6 NORTH COLUMBIA ST.
NAPERVILLE, IL 60540**

REV: 12/21/2020

REV: 11/09/2016

DATE: 10/11/2016

A-1

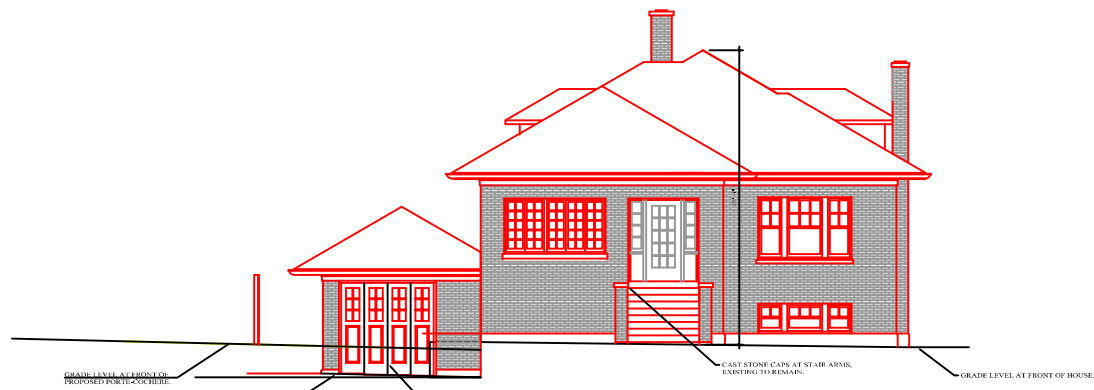

**WEST ELEVATION
EXISTING CONDITIONS**

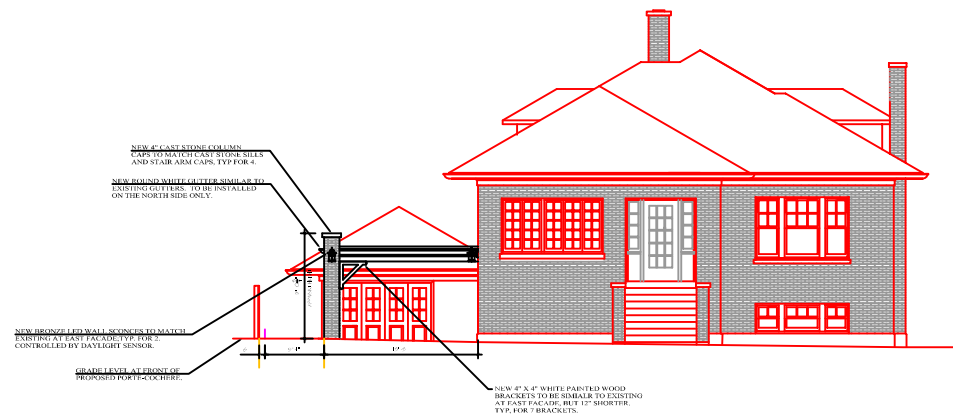

**WEST ELEVATION WITH
PROPOSED PORTE-COCHERE**

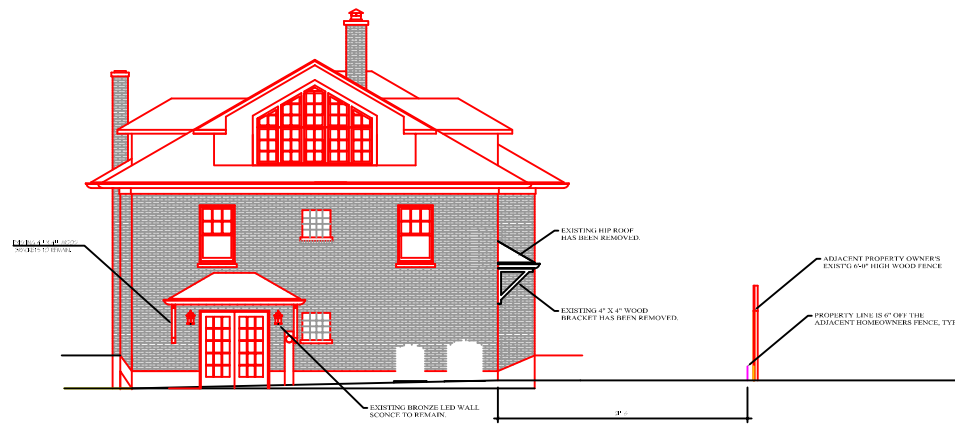

**EAST ELEVATION
EXISTING CONDITIONS**

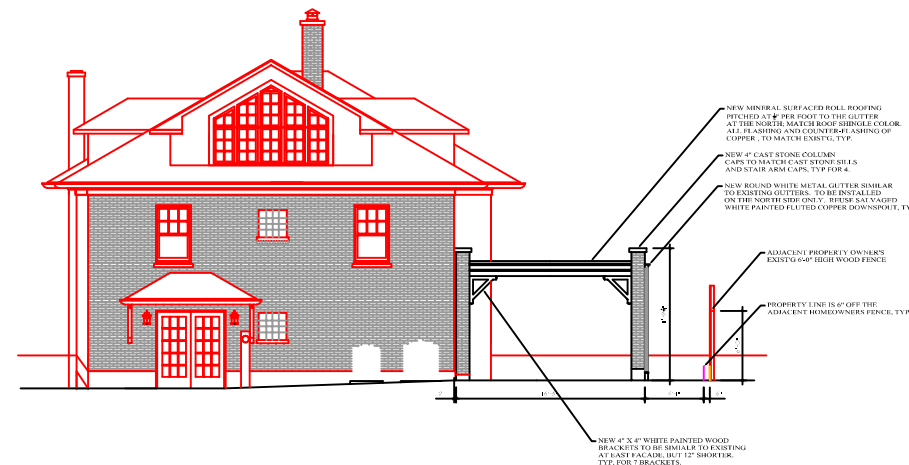

**EAST ELEVATION WITH
PROPOSED PORTE-COCHERE**



**NORTH ELEVATION
EXISTING CONDITIONS**

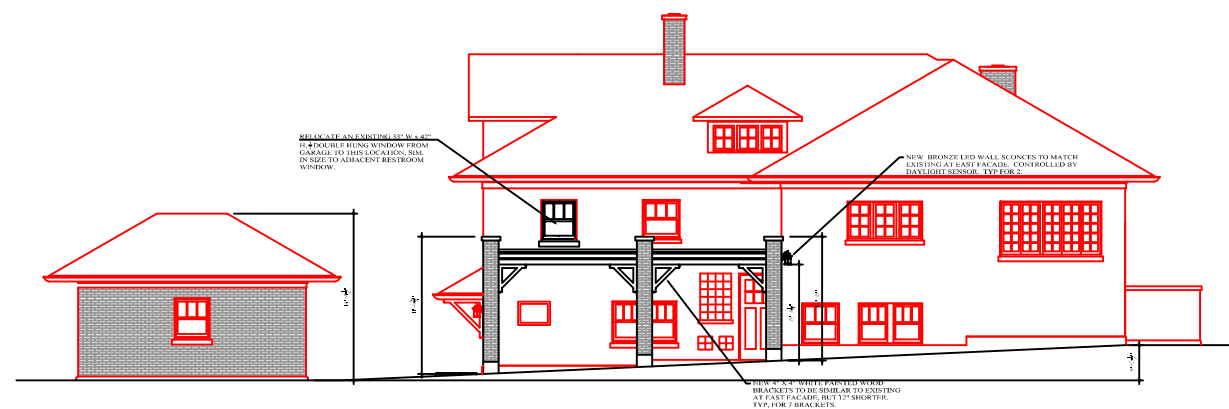

**NORTH ELEVATION WITH
PROPOSED PORTE-COCHERE**

**NEW PORTE-COCHERE AT
6 NORTH COLUMBIA ST.
NAPERVILLE, IL 60540**

REV: 12/21/2020

REV: 11/09/2016

DATE: 10/11/2016