

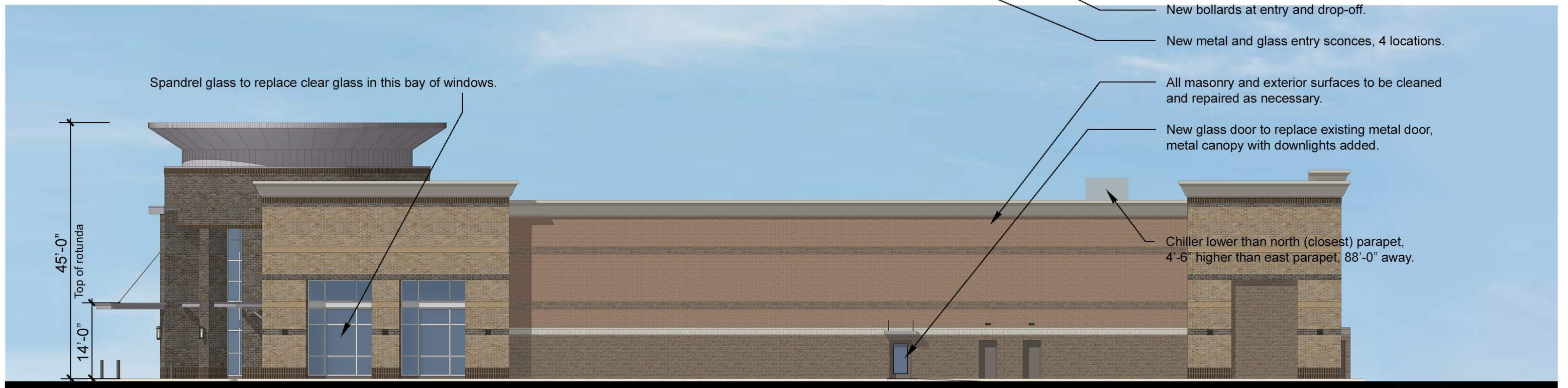

South Elevation



East Elevation



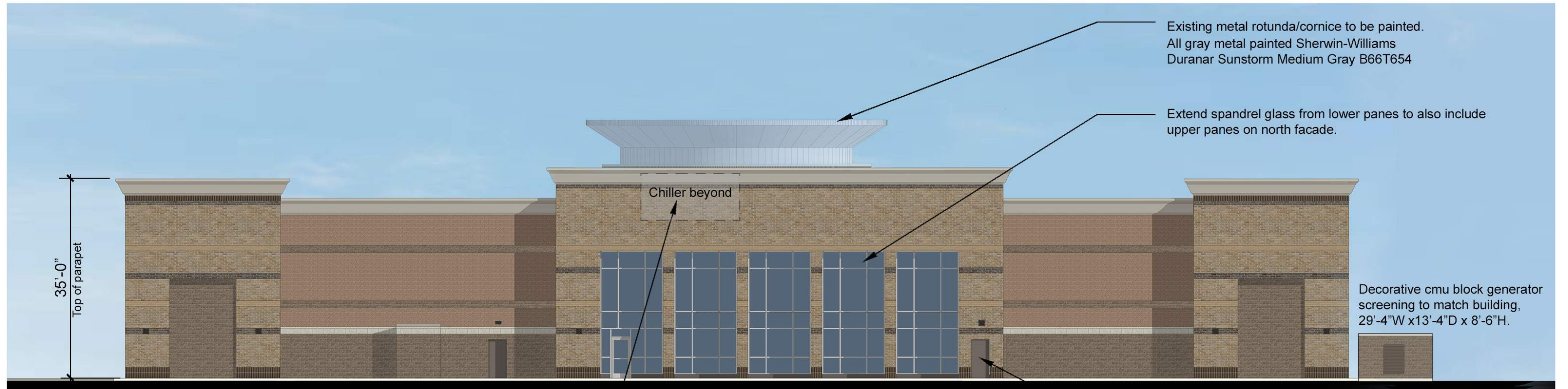

North Elevation

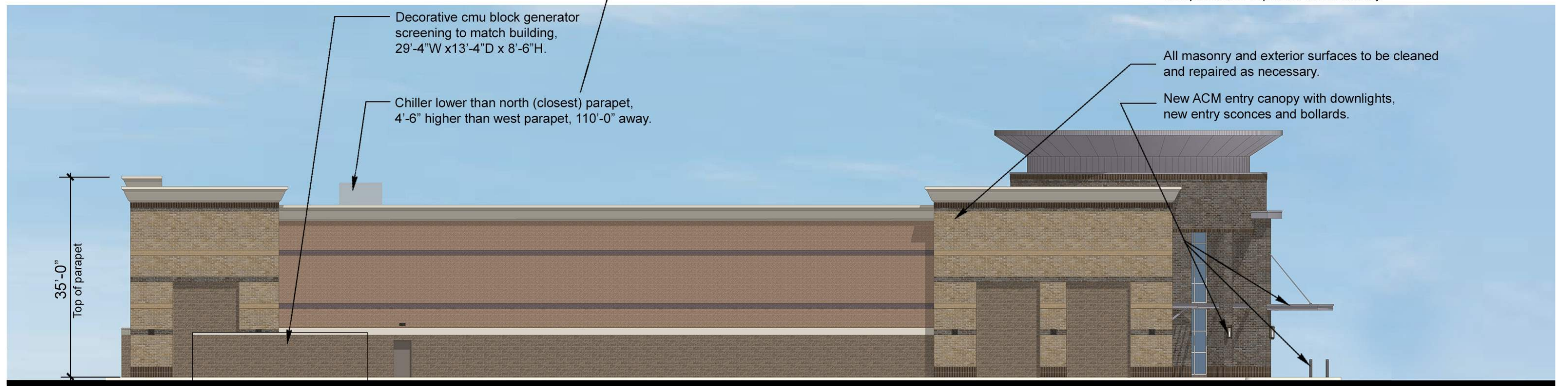

West Elevation



Trash and generator enclosures with split face cmu to match the building. Trash enclosure with steel gate structure with composite wood fronts.

Bollard Cover R-7307

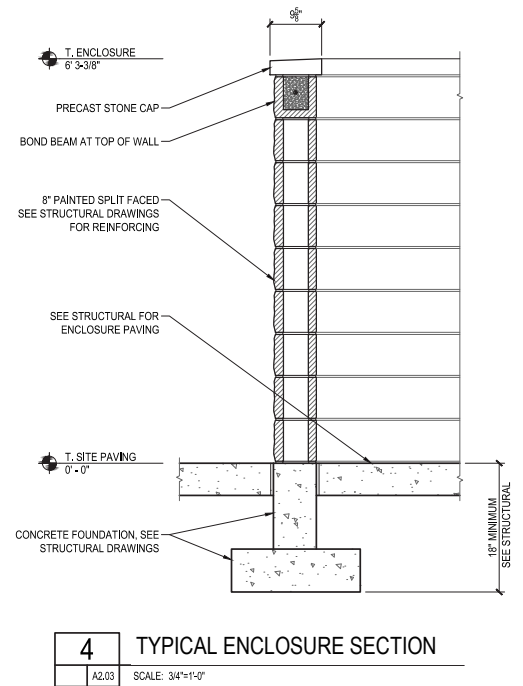
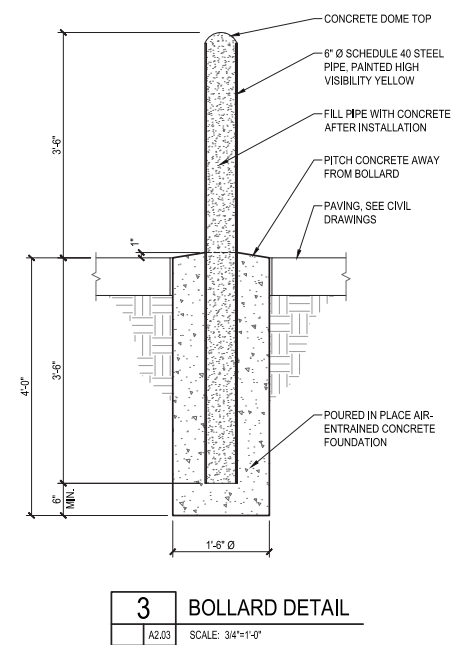
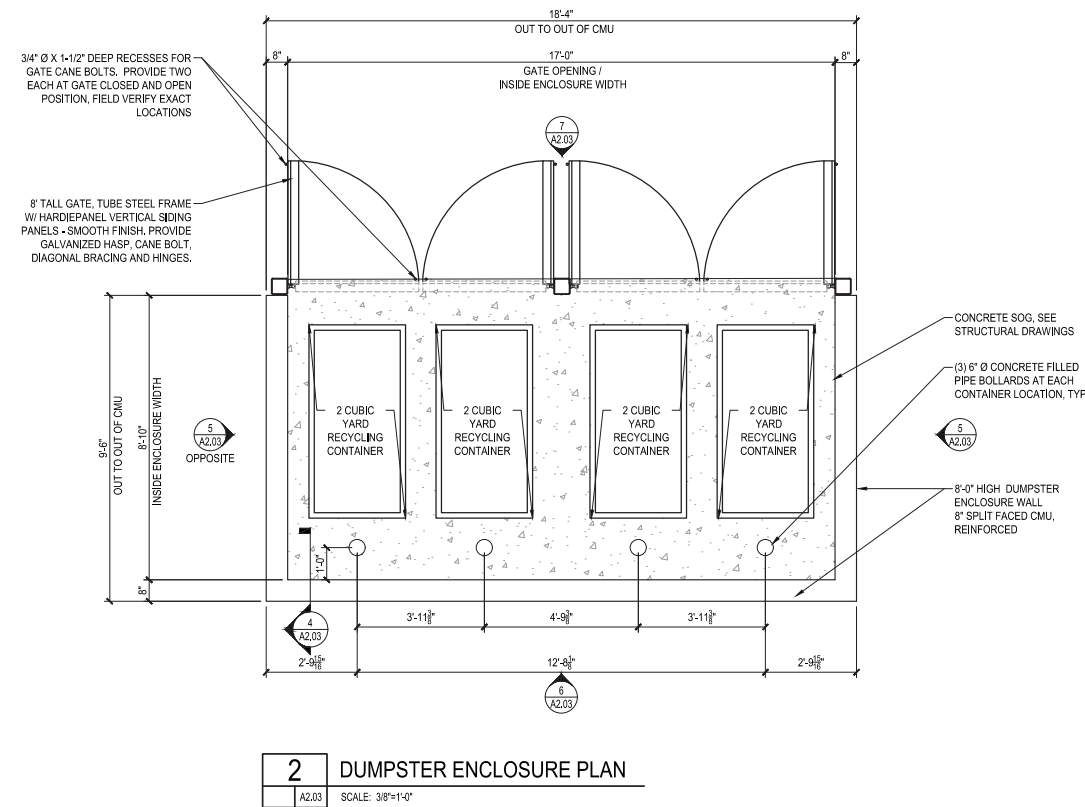
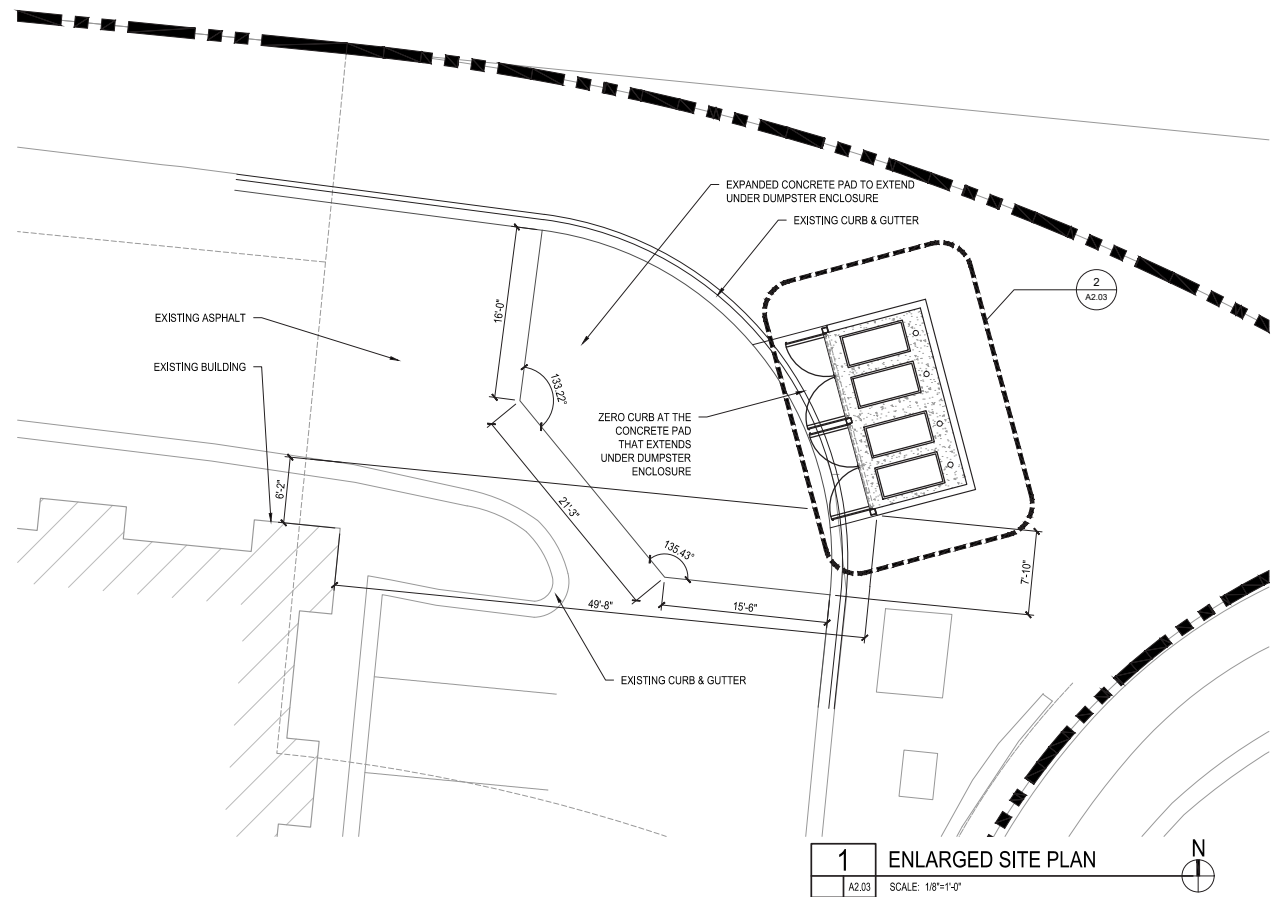
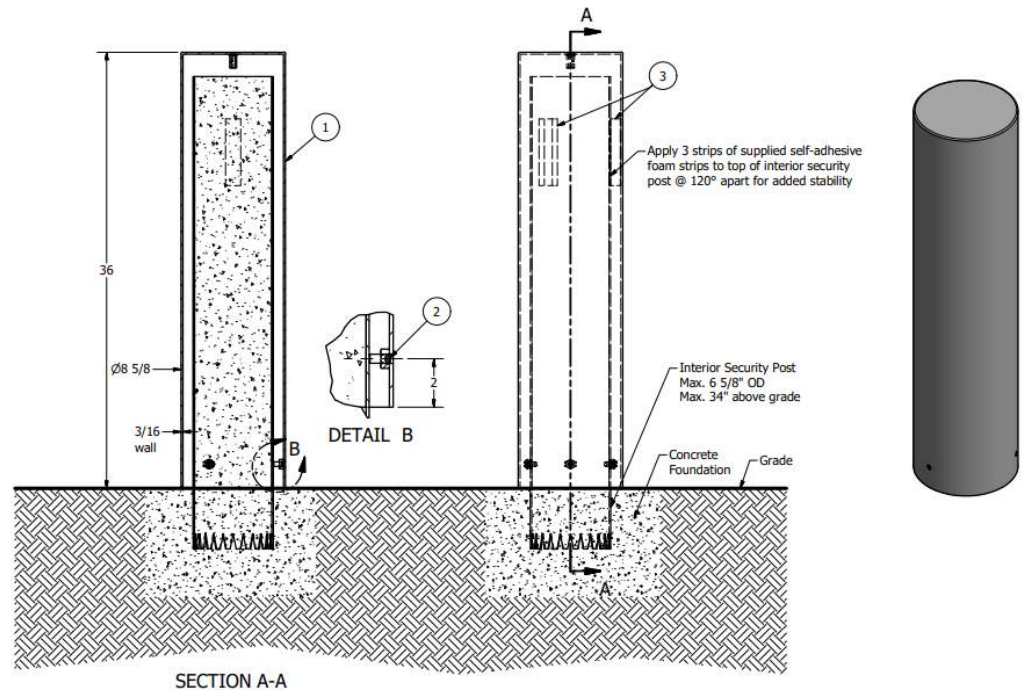



NAPERVILLE MEDICAL COMMONS

ANTUNOVICH ASSOCIATES • ARCHITECTURE, PLANNING, INTERIOR DESIGN • CAPITAL HEALTHCARE PROPERTIES • DEVELOPER • HITCHCOCK DESIGN GROUP • LANDSCAPE ARCHITECT • V3 • CIVIL ENGINEER

BUILDING IMAGE

NAPERVILLE, ILLINOIS • FEBRUARY 21, 2024



NAPERVILLE MEDICAL COMMONS

ANTUNOVICH ASSOCIATES • ARCHITECTURE, PLANNING, INTERIOR DESIGN • CAPITAL HEALTHCARE PROPERTIES • DEVELOPER • HITCHCOCK DESIGN GROUP • LANDSCAPE ARCHITECT • V3 • CIVIL ENGINEER

BUILDING IMAGE

NAPERVILLE, ILLINOIS • FEBRUARY 21, 2024



NAPERVILLE MEDICAL COMMONS

ANTUNOVICH ASSOCIATES • ARCHITECTURE, PLANNING, INTERIOR DESIGN • CAPITAL HEALTHCARE PROPERTIES • DEVELOPER • HITCHCOCK DESIGN GROUP • LANDSCAPE ARCHITECT • V3 • CIVIL ENGINEER

BUILDING IMAGE

NAPERVILLE, ILLINOIS • FEBRUARY 21, 2024



NAPERVILLE MEDICAL COMMONS

ANTUNOVICH ASSOCIATES • ARCHITECTURE, PLANNING, INTERIOR DESIGN • CAPITAL HEALTHCARE PROPERTIES • DEVELOPER • HITCHCOCK DESIGN GROUP • LANDSCAPE ARCHITECT • V3 • CIVIL ENGINEER

BUILDING IMAGE

NAPERVILLE, ILLINOIS • FEBRUARY 21, 2024