

Luminaire Schedule - Part numbers are provided by the manufacturer and are only intended to be used as a reference to output and optics used.								
Symbol	Qty	Tag	Arrangement	Luminaire Lumens	Luminaire Watts	LLF	Manufacturer	Description
	7	S1-4W	Single	20492	143	0.800	EXO	ASL2-320L-145-4K7-4W-U
	6	W1	WALL	3060	29.1	0.800	EXO	SG1-30-4K7-FT

Calculation Summary									
Label	CalcType	Units	Avg	Max	Min	Max/Min	Avg/Min	Description	
PARKING & DRIVES Planar	Illuminance	Fc	2.61	10.3	0.5	20.60	5.22	READINGS TAKEN @ GRADE	
PROPERTY LINE	Illuminance	Fc	0.19	1.1	0.0	N.A.	N.A.	READINGS TAKEN @ GRADE	
PAY AREA	Illuminance	Fc	2.90	3.5	1.7	2.06	1.71	READINGS TAKEN @ GRADE	

Luminaire Location Summary				
LumNo	Label	Mtg Ht	Orient	Tilt
1	ASL2-320L-145-4K7-4W	25	186	0
2	ASL2-320L-145-4K7-4W	25	184	0
3	ASL2-320L-145-4K7-4W	25	275	0
4	ASL2-320L-145-4K7-4W	25	275	0
5	ASL2-320L-145-4K7-4W	25	94	0
6	ASL2-320L-145-4K7-4W	25	94	0
7	ASL2-320L-145-4K7-4W	25	0	0
8	SG1-30-4K7-FT	8	4	0
9	SG1-30-4K7-FT	8	4	0
10	SG1-30-4K7-FT	8	183	0
11	SG1-30-4K7-FT	8	275	0
12	SG1-30-4K7-FT	8	5	0
13	SG1-30-4K7-FT	8	94	0

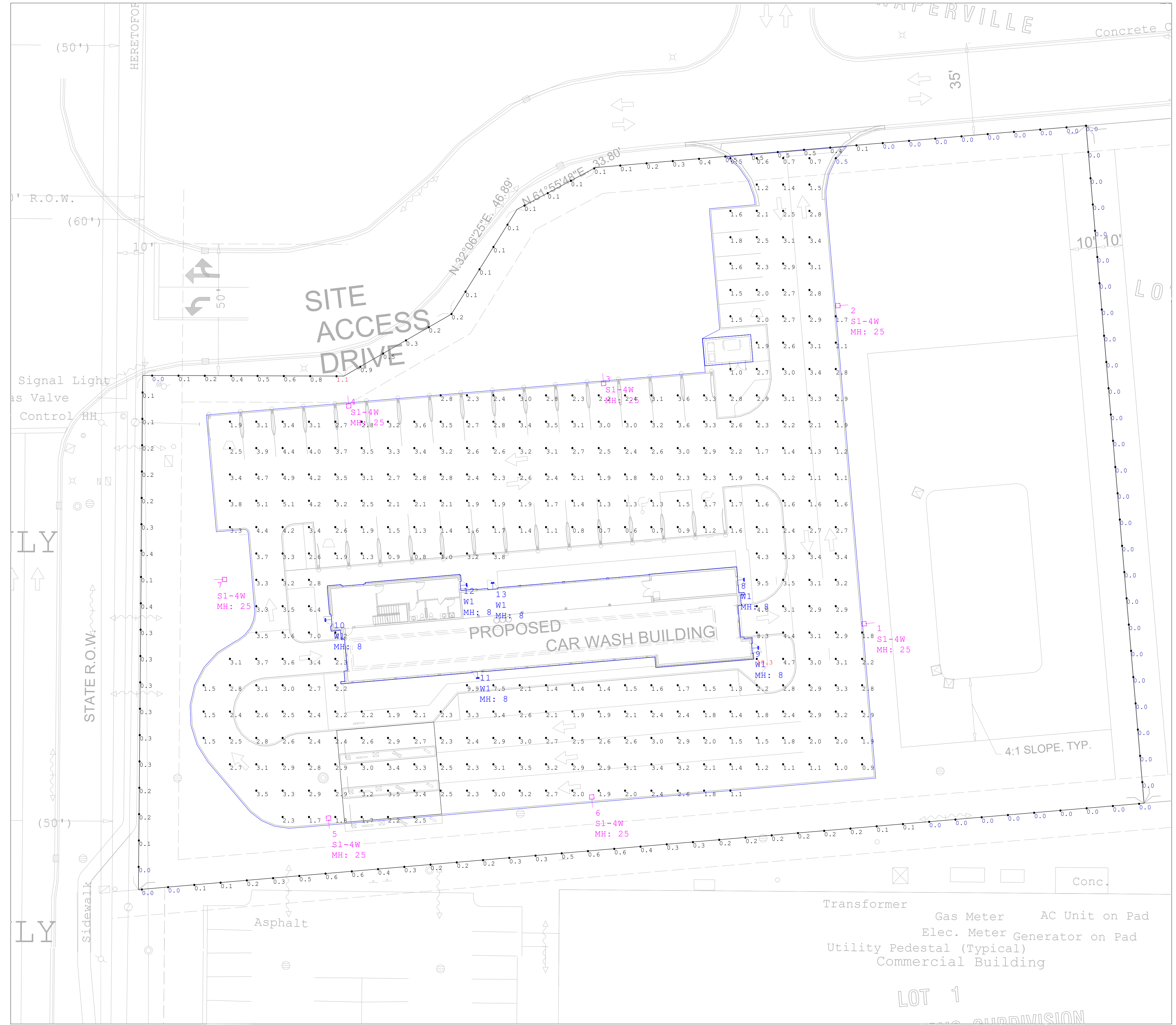

PARKING LOT DESIGN GUIDE	MAINTAINED HORIZONTAL		MAINTAINED VERTICAL		MAXIMUM	
	AVERAGE (FC)	RANGE (FC)	AVERAGE (FC)	RANGE (FC)	AVG:MIN	MAX:MIN
PARKING (UNCOVERED) ZONE 3 (URBAN)	1.5	0.75 - 3	0.8	0.4 - 1.6	4:1	15:1
PARKING (UNCOVERED) ZONE 2 (SUBURBAN)	1	0.5 - 2	0.6	0.3 - 1.2	4:1	15:1
SAFETY (BUILDING EXTERIOR)	1	0.5 - 2	-	-	FOR SECURITY ISSUES, RAISE AVG. TO 3	

SIMPLIFIED RECOMMENDATIONS BASED ON IES 'THE LIGHTING HANDBOOK' 10TH EDITION AND IES RP-20-14. INDIVIDUAL APPLICATIONS WILL DETERMINE SPECIFIC RECOMMENDATIONS. PLEASE REFER TO THE MOST RECENT HANDBOOK FOR A MORE DETAILED EVALUATION AND ADDITIONAL APPLICATIONS. THESE RECOMMENDATIONS DO NOT SUPERCEDE ANY APPLICABLE CODES.

NOTES

PG-ENLIGHTEN IS NEITHER LICENSED NOR INSURED TO DETERMINE CODE COMPLIANCE. CODE COMPLIANCE REVIEW BY OTHERS.

ANY VARIANCE FROM REFLECTANCE VALUES, OBSTRUCTIONS, LIGHT LOSS FACTORS OR DIMENSIONAL DATA WILL AFFECT THE ACTUAL LIGHT LEVELS OBTAINED.

THIS ANALYSIS IS A MATHEMATICAL MODEL AND CAN BE ONLY AS ACCURATE AS IS PERMITTED BY THE THIRD-PARTY SOFTWARE AND THE IES STANDARDS USED.

FIXTURE TYPES AND QUANTITIES MAY CHANGE BASED ON UNKNOWN OBSTRUCTIONS OR FIELD CONDITIONS. THESE CHANGES MAY RESULT IN AN INCREASED QUANTITY OF FIXTURES.

FIXTURE TYPES AND QUANTITIES BASED ON PROVIDED LAYOUT AND DRAWINGS ARE FOR REFERENCE ONLY. TYPES AND QUANTITIES MAY CHANGE WITH FUTURE REVISIONS.

CALCULATION GRID VALUES 10'-0" O.C.

We (property owner or agent and the preparer of the plan) certify that the exterior site lighting as depicted herein, complies with the requirements of this Chapter (Title 6-Zoning Regulations/chapt 14 - performance standards. Once the plan is approved, the exterior lighting of the property shall conform to the approved plan.

Scale: 1 inch= 20 Ft.



DRAWN BY:
Jose Saucedo
jose.saucedo@pgenlighten.com
847.756.1276

PG CONTACT:
Patti Geier
Patti.Geier@pgenlighten.com
847.728.1199

1	2	3

REVISIONS

PROJECT NAME:
NAPERVILLE IL CARWASH

CLIENT NAME:
NERI ARCHITECTS

Date:10/13/2023

Page 1 of 2

Luminaire Schedule - Part numbers are provided by the manufacturer and are only intended to be used as a reference to output and optics used.								
Symbol	Qty	Tag	Arrangement	Luminaire Lumens	Luminaire Watts	LLF	Manufacturer	Description
	7	S1-4W	Single	20492	143	0.800	EXO	ASL2-320L-145-4K7-4W-U
	6	W1	WALL	3060	29.1	0.800	EXO	SG1-30-4K7-FT

Calculation Summary									
Label	CalcType	Units	Avg	Max	Min	Max/Min	Avg/Min	Description	
PARKING & DRIVES Planar	Illuminance	Fc	2.61	10.3	0.5	20.60	5.22	READINGS TAKEN @ GRADE	
PROPERTY LINE	Illuminance	Fc	0.19	1.1	0.0	N.A.	N.A.	READINGS TAKEN @ GRADE	
PAY AREA	Illuminance	Fc	2.90	3.5	1.7	2.06	1.71	READINGS TAKEN @ GRADE	

Luminaire Location Summary				
LumNo	Label	Mtg Ht	Orient	Tilt
1	ASL2-320L-145-4K7-4W	25	186	0
2	ASL2-320L-145-4K7-4W	25	184	0
3	ASL2-320L-145-4K7-4W	25	275	0
4	ASL2-320L-145-4K7-4W	25	275	0
5	ASL2-320L-145-4K7-4W	25	94	0
6	ASL2-320L-145-4K7-4W	25	94	0
7	ASL2-320L-145-4K7-4W	25	0	0
8	SG1-30-4K7-FT	8	4	0
9	SG1-30-4K7-FT	8	4	0
10	SG1-30-4K7-FT	8	183	0
11	SG1-30-4K7-FT	8	275	0
12	SG1-30-4K7-FT	8	5	0
13	SG1-30-4K7-FT	8	94	0

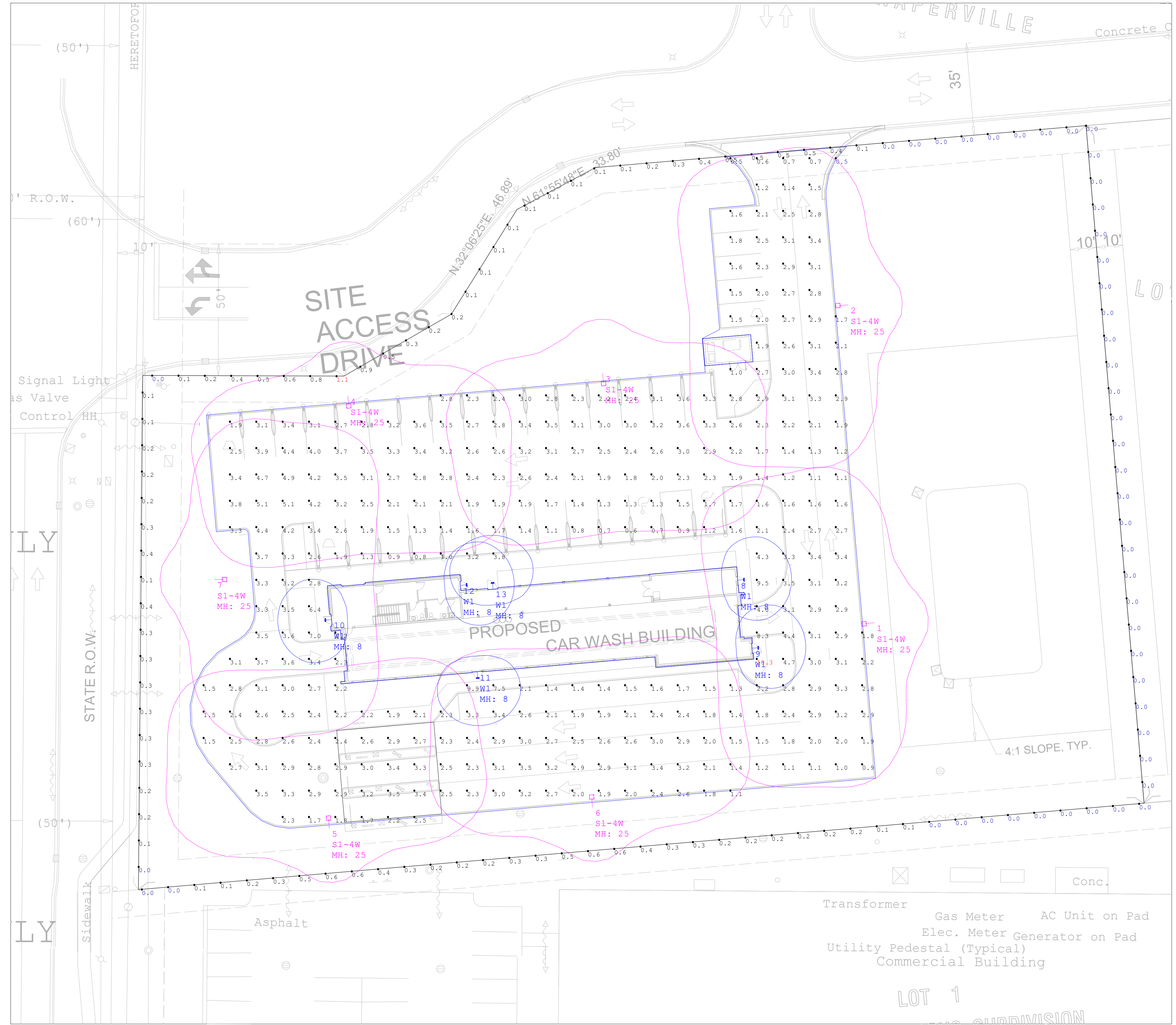

PARKING LOT DESIGN GUIDE	MAINTAINED HORIZONTAL		MAINTAINED VERTICAL		MAXIMUM	
	AVERAGE (FC)	RANGE (FC)	AVERAGE (FC)	RANGE (FC)	AVG:MIN	MAX:MIN
PARKING (UNCOVERED) ZONE 3 (URBAN)	1.5	0.75 - 3	0.8	0.4 - 1.6	4:1	15:1
PARKING (UNCOVERED) ZONE 2 (SUBURBAN)	1	0.5 - 2	0.6	0.3 - 1.2	4:1	15:1
SAFETY (BUILDING EXTERIOR)	1	0.5 - 2	-	-	FOR SECURITY ISSUES, RAISE AVG. TO 3	

SIMPLIFIED RECOMMENDATIONS BASED ON IES 'THE LIGHTING HANDBOOK' 10TH EDITION AND IES RP-20-14. INDIVIDUAL APPLICATIONS WILL DETERMINE SPECIFIC RECOMMENDATIONS. PLEASE REFER TO THE MOST RECENT HANDBOOK FOR A MORE DETAILED EVALUATION AND ADDITIONAL APPLICATIONS. THESE RECOMMENDATIONS DO NOT SUPERCEDE ANY APPLICABLE CODES.

NOTES

PG-ENLIGHTEN IS NEITHER LICENSED NOR INSURED TO DETERMINE CODE COMPLIANCE. CODE COMPLIANCE REVIEW BY OTHERS.

ANY VARIANCE FROM REFLECTANCE VALUES, OBSTRUCTIONS, LIGHT LOSS FACTORS OR DIMENSIONAL DATA WILL AFFECT THE ACTUAL LIGHT LEVELS OBTAINED.

THIS ANALYSIS IS A MATHEMATICAL MODEL AND CAN BE ONLY AS ACCURATE AS IS PERMITTED BY THE THIRD-PARTY SOFTWARE AND THE IES STANDARDS USED.

FIXTURE TYPES AND QUANTITIES MAY CHANGE BASED ON UNKNOWN OBSTRUCTIONS OR FIELD CONDITIONS. THESE CHANGES MAY RESULT IN AN INCREASED QUANTITY OF FIXTURES.

FIXTURE TYPES AND QUANTITIES BASED ON PROVIDED LAYOUT AND DRAWINGS ARE FOR REFERENCE ONLY. TYPES AND QUANTITIES MAY CHANGE WITH FUTURE REVISIONS.

CALCULATION GRID VALUES 10'-0" O.C.



DRAWN BY:
Jose Saucedo
jose.saucedo@pgenlighten.com
847.756.1276

PG CONTACT:
Patti Geier
Patti.Geier@pgenlighten.com
847.728.1199

1	2	3

PROJECT NAME:
NAPERVILLE IL CARWASH

CLIENT NAME:
NERI ARCHITECTS

SLING Micro Strike

AREA/SITE/ROAD LIGHTER

FEATURES

- Compact sleek design with multiple LED configurations and simple installation
- The SLING includes a square mounting block for easy pole installation or mast arm option for 2-3/8 ft OD roadway brackets
- Capable of replacing up to 1000w HID luminaires
- Micro Strike optical distributions of Type 2, 3, 4F, 4W or 5QW
- Tool-less entry option for easy installation and maintenance
- 1.5G rated for high vibration applications including bridges and overpasses



10-DAY QUICK SHIP PROGRAM



CONTROL TECHNOLOGY



SPECIFICATIONS

CONSTRUCTION

- Die-cast housing with hidden vertical heat fins that are optimal for heat dissipation while keeping a clean smooth outer surface
- Corrosion resistant, die-cast aluminum housing with powder coat paint finish
- Separate optical and electrical compartment for improved thermal management and optimum component operation
- TGIC thermoset polyester powder paint finish applied at nominal 2.5 mil thickness

OPTICS

- Entire optical aperture illuminates to create a larger luminous surface area resulting in a low glare appearance without sacrificing optical performance
- Premium engineered individual acrylic lenses deliver IES Type 2, 3, 4F, 4W and 5QW distributions
- Lens distributions are field rotatable (in 90° increments) or exchangeable for job site fine-tuning
- 3000K, 4000K or 5000K (70 CRI) CCT
- 80, 160 or 320 midpower LEDs
- 3000K, 4000K or 5000K (70 CRI) CCT
- Zero uplight at 0 degrees of tilt
- Field rotatable optics

INSTALLATION

- Tool-less entry to wiring/driver compartment optional
- Arm mounting works with S2 drill pattern
- Fixture ships with square mounting block for ease of installation
- Mast arm fitter accessory or option available for 2-3/8" OD brackets with vertical tilt of +3°, 0° or -3°

ELECTRICAL

- Universal 120-277 VAC or 347-480 VAC input voltage, 50/60 Hz
- Ambient operating temperature -40° C to 40° C
- Drivers have greater than 90% power factor and less than 20% THD
- LED drivers have output power over-voltage, over-current protection and short circuit protection with auto recovery
- Standard 6kV surge protection with optional field replaceable surge protection device provides 20KA and 10KV protection meeting ANSI/IEEE C62.41.2 Category C High and Surge Location Category C3; Automatically takes fixture off-line for protection when device is consumed

CONTROLS

- Photo control, occupancy sensor and Zigbee wireless available for complete on/off and dimming control
- 7-pin ANSI C136.41-2013 photocontrol receptacle option available for twist lock photocontrols or wireless control modules (control accessories sold separately)
- Dimming Drivers are standard and dimming leads are extended out of the luminaire unless control options require connection to the dimming leads. Must specify if wiring leads are to be greater than the 6
- Please consult brand or sales representative when combining control and electrical options as some combinations may not operate as anticipated depending on your application

CERTIFICATIONS

- Listed to UL1598 and CSA C22.2#2500-24 for wet locations and 40°C ambient temperatures
- DLC® (DesignLights Consortium Qualified), with some Premium Qualified configurations. Not all product variations on this page are DLC Qualified. Refer to <http://www.designlights.org/> for the most up-to-date list.
- 1.5G rated for ANSI C136.31 high vibration applications
- IP65 optical assembly
- Meets IDA recommendations using 3K CCT configuration at 0 degrees of tilt
- This product qualifies as a "designated country construction material" per FAR 52.225-11 Buy American-Construction Materials under Trade Agreements effective 04/23/2020.

WARRANTY

- 5 Year warranty

KEY DATA	
Lumen Range	3,200-36,000
Wattage Range	25-255
Efficacy Range (LPW)	118-148
Weight lbs. (kg)	14.5-17.5 (6.6-8.0)

DATE: _____ LOCATION: _____
 TYPE: _____ PROJECT: _____
 CATALOG #: _____

SLING Micro Strike

AREA/SITE/ROAD LIGHTER

= Service Program
 Limit of 15 luminaires 

ORDERING GUIDE

Example: ASL1-80L-50-3K7-2-UNV-ASQU-BLT-7PRMD-40F

CATALOG #

ORDERING INFORMATION

Series	# LEDs	CCT/CRI	Distribution	Voltage	Mounting
ASL1 ASL Microstrike Series	80L-25	3,000 lm	2 Type II	UNV Universal 120-277V	A Arm for Square poles with S2 drill pattern
	80L-39	4,500 lm	3 Type III	120 120V	A3 Square Arm with 3.25"-3.75" OD RPA3 Adapter
	80L-50	6,000 lm	4F Type 4F	208 208V	A4 Square Arm with 3.875"-4.5" OD RPA4 Adapter
	160L-70	9,000 lm	4W Type 4W	240 240V	A5 Square Arm with 5" OD RPA5 Adapter
	160L-100	12,000 lm	5QW Type 5QW	277 277V	MAF Mast Arm Fitter for 2-3/8" OD
	160L-115	15,000 lm		347 347V	
	160L-135	18,000 lm		480 480V	
ASL2 ASL Microstrike Series	320L-145	21,000 lm			
	320L-170	24,000 lm			
	320L-185	27,000 lm			
	320L-210	30,000 lm			
	320L-235	33,000 lm			
	320L-255	35,000 lm			

Network Control Options	Options	Color
NXWS16F NX Networked Wireless Enabled Integral NXSMP2-LMO PIR Occupancy Sensor with Automatic Dimming Photocell and Bluetooth Programming ^{1,3,4}	F¹ Fusing	BLT Black Matte Textured
NXWS40F NX Networked Wireless Enabled Integral NXSMP2-HMO PIR Occupancy Sensor with Automatic Dimming Photocell and Bluetooth Programming ^{1,3,4}	BC Backlight Control ⁴	BLS Black Gloss Smooth
NXW NX Networked Wireless Radio Module NXRM2 and Bluetooth Programming, without Sensor ^{3,4}	SP 20kA & 10kV Surge Protector	DBT Dark Bronze Matte Textured
WIR LightGRID+ In-Fixture Module ^{3,4}		DBS Dark Bronze Gloss Smooth
WIRSC LightGRID+ Module and Occupancy Sensor ^{3,4}		GTT Graphite Matte Textured
Stand Alone Sensors		LGS Light Grey Gloss Smooth
7PR 7 Pin Receptacle		LGT Light Grey Matte Textured
7PR-SC 7 Pin Receptacle with shorting cap		PSS Platinum Silver Smooth
7PR-MD8F 7 pin receptacle with low voltage sensor at 8' mounting for external control accessory		WHT White Matte Textured
7PR-MD40F 7 pin receptacle with low voltage sensor at 40' mounting for external control accessory		WHS White Gloss Smooth
7PR-TL 7 Pin Receptacle with Photocontrol		VGT Verde Green Textured
Sensors		Color Option
BTS_F Bluetooth Programmable, PIR Occupancy/Daylight Sensor, 360° lens ²		CC Custom Color
BTSO_F Bluetooth Programmable, PIR Occupancy/Daylight Sensor, 360° lens, up to 12' mounting height ³		

Notes:

- 1 Must specify Voltage
- 2 Replace "_" with "14" for up to 14' mounting height, "40F" for 15-40' mounting height
- 3 Replace "_" with "12" for up to 12' mounting height
- 4 Not available with 4F optic

SLING Micro Strike

AREA/SITE/ROAD LIGHTER

ACCESSORIES (ORDERED SEPARATELY)

Catalog Number	Description
<input type="checkbox"/> ASL1-HSS-90-B-XXX ¹	House Side Shield Back 90 deg
<input type="checkbox"/> ASL1-HSS-90-F-XXX ¹	House Side Shield Front 90 deg
<input type="checkbox"/> ASL1-HSS-90-S-XXX ¹	House Side Shield Side 90 deg
<input type="checkbox"/> ASL1-HSS-270-BSS-XXX ¹	House Side Shield Back, Side & Side 270 deg
<input type="checkbox"/> ASL1-HSS-270-FSS-XXX ¹	House Side Shield Front, Side & Side 270 deg
<input type="checkbox"/> ASL1-HSS-270-FSB-XXX ¹	House Side Shield Front, Side & Back 270 deg
<input type="checkbox"/> ASL1-HSS-360-XXX ¹	House Side Shield 360 deg
<input type="checkbox"/> ASL2-HSS-90-B-XXX ¹	House Side Shield Back 90 deg
<input type="checkbox"/> ASL2-HSS-90-F-XXX ¹	House Side Shield Front 90 deg
<input type="checkbox"/> ASL2-HSS-90-S-XXX ¹	House Side Shield Side 90 deg
<input type="checkbox"/> ASL2-HSS-270-BSS-XXX ¹	House Side Shield Back, Side & Side 270 deg
<input type="checkbox"/> ASL2-HSS-270-FSS-XXX ¹	House Side Shield Front, Side & Side 270 deg
<input type="checkbox"/> ASL2-HSS-270-FSB-XXX ¹	House Side Shield Front, Side & Back 270 deg
<input type="checkbox"/> ASL2-HSS-360-XXX ¹	House Side Shield 360 deg
<input type="checkbox"/> ASL-MAF	Mast arm kit with wildlife shield for mounting on 2 3/8" OD arms
<input type="checkbox"/> SETA2-XX ¹	Square pole tenon adapter (4 at 90 degrees) (2 3/8" OD tenon)
<input type="checkbox"/> RETA2-XX ¹	Round pole tenon adapter (4 at 90 degrees) (2 3/8" OD tenon), requires CL1S-RPA4-ACC-XX for each luminaire
<input type="checkbox"/> RARBC80L	Backlight Control 80L
<input type="checkbox"/> RARBC160L	Backlight Control 160L
<input type="checkbox"/> RARBC320L	Backlight Control 320L
<input type="checkbox"/> RARBC480L	Backlight Control 480L
<input type="checkbox"/> CL1S-RPA*-ACC-CC ¹	Round Pole Adapter (*denotes pole diameter 3=3.25"-3.75", 4=3.875"-4.5", 5=5" and paint color replaces CC
<input type="checkbox"/> ASL-ARMMTG-XX ¹	Arm mounting kit for side of pole attachment
<input type="checkbox"/> WB-AREA-XX ¹	Wall bracket, Compatible with standard arm mount option
<input type="checkbox"/> ASL-MAF	Mast arm kit with wildlife shield for mounting on 2 3/8" OD arms

¹ Replace XX or XXX with color choice, eg.: DB for Dark Bronze or BLT for Black Matte Textured

SLING Micro Strike

AREA/SITE/ROAD LIGHTER

PERFORMANCE DATA

Description	Nominal Wattage	System Watts	Dist. Type	5K (5000K NOMINAL 70 CRI)					4K (4000K NOMINAL 70 CRI)					3K (3000K NOMINAL 70 CRI)				
				Lumens	LPW ¹	B	U	G	Lumens	LPW ¹	B	U	G	Lumens	LPW ¹	B	U	G
ASL1	25	25.4	2	3430	135	2	0	2	3413	134	2	0	2	3225	127	2	0	2
			3	3465	136	2	0	2	3448	136	2	0	2	3259	128	2	0	2
			4F	3204	126	1	0	1	3201	126	1	0	1	3127	123	1	0	1
			4W	3401	134	2	0	3	3384	133	2	0	3	3198	126	2	0	3
			5QW	3483	137	4	0	2	3466	136	4	0	2	3274	129	4	0	2
	39	38.0	4F	5005	132	1	0	1	5000	132	1	0	1	4885	129	1	0	1
			2	5232	138	3	0	3	5206	137	3	0	3	4919	129	3	0	3
			3	5287	139	2	0	2	5260	138	2	0	2	4971	131	2	0	2
			4W	5188	137	2	0	3	5163	136	2	0	3	4879	128	2	0	3
	50	49.7	2	6295	127	2	0	2	6263	126	2	0	2	5918	119	2	0	2
			3	6361	128	2	0	2	6329	127	2	0	2	5981	120	2	0	2
			4F	6407	129	1	0	2	6401	129	1	0	2	6254	126	1	0	2
			4W	6243	126	2	0	3	6212	125	2	0	3	5870	118	2	0	3
	70	68.4	5QW	6392	129	4	0	2	6360	128	4	0	2	6009	121	4	0	2
			2	9460	138	3	0	3	9413	138	3	0	3	8895	130	3	0	3
			3	9559	140	2	0	2	9512	139	2	0	2	8989	131	2	0	2
			4F	8988	131	2	0	2	8979	131	2	0	2	8772	128	2	0	2
	100	88.0	4W	9382	137	2	0	3	9335	136	2	0	3	8822	129	2	0	3
			5QW	9610	140	4	0	2	9562	140	4	0	2	9034	132	4	0	2
			2	11939	136	2	0	2	11885	135	2	0	2	11232	128	2	0	2
			3	12064	138	2	0	2	12010	136	2	0	2	11349	129	2	0	2
	115	109.7	4F	12832	146	2	0	2	12819	146	2	0	2	12524	142	2	0	2
			4W	11840	135	2	0	3	11787	135	2	0	3	11138	127	2	0	3
			5QW	12132	138	4	0	2	12071	138	4	0	2	11404	130	4	0	2
			2	15651	143	2	0	2	15577	142	2	0	2	14977	137	2	0	2
			3	15487	141	2	0	2	15413	140	2	0	2	14820	135	2	0	2
	135	133.3	4F	14754	134	2	0	2	14740	134	2	0	2	14401	131	2	0	2
			4W	15305	140	2	0	3	15232	139	2	0	3	14646	134	2	0	3
5QW			15731	143	4	0	2	15632	143	4	0	2	15031	137	4	0	2	
2			18089	136	3	0	3	17999	135	3	0	3	17275	130	3	0	3	
3			17863	134	2	0	2	17777	133	2	0	2	17094	128	2	0	2	
			4F	17317	130	3	0	3	17300	130	3	0	3	16902	127	2	0	3
			4W	17653	133	2	0	3	17568	132	2	0	3	16893	127	2	0	3
			5QW	18155	136	4	0	2	18030	135	4	0	2	17338	130	4	0	2

ASL2 Performance Data on next page

¹ VAC input Lumen values are from photometric test performed in accordance with IESNA LM-79-08. Data is considered to be representative of the configurations. Actual performance may differ as a result of end-user environment and application.

SLING Micro Strike

AREA/SITE/ROAD LIGHTER

PERFORMANCE DATA

Description	Nominal Wattage	System Watts	Dist. Type	5K (5000K NOMINAL 70 CRI)					4K (4000K NOMINAL 70 CRI)					3K (3000K NOMINAL 70 CRI)				
				Lumens	LPW ¹	B	U	G	Lumens	LPW ¹	B	U	G	Lumens	LPW ¹	B	U	G
ASL2	145	143.0	2	21007	147	3	0	4	20902	146	3	0	4	20061	140	3	0	4
			3	20842	146	3	0	4	20738	145	3	0	4	19904	139	3	0	4
			4F	19490	136	3	0	3	19471	136	3	0	3	19023	133	3	0	3
			4W	20595	144	3	0	5	20492	143	3	0	5	19669	138	3	0	5
			5QW	21130	148	5	0	4	21024	147	5	0	4	20179	141	5	0	4
	170	168.0	2	24452	146	3	0	4	24330	145	3	0	4	23351	139	3	0	4
			3	24260	144	3	0	4	24139	144	3	0	4	23168	138	3	0	4
			4F	22847	136	3	0	4	22824	136	3	0	4	22299	133	3	0	3
			4W	23972	143	3	0	5	23853	142	3	0	5	22895	136	3	0	5
			5QW	24596	146	5	0	4	24472	146	5	0	4	23488	140	5	0	4
	185	185.0	2	26658	144	4	0	5	26525	143	4	0	5	25457	138	4	0	5
			3	26449	143	3	0	4	26316	142	3	0	4	25258	137	3	0	4
			4F	24834	134	3	0	4	24809	134	3	0	4	24238	131	3	0	3
			4W	26135	141	4	0	5	26005	141	4	0	5	24961	135	4	0	5
			5QW	26814	145	5	0	5	26680	144	5	0	5	25607	138	5	0	5
	210	210.0	2	29872	142	3	0	4	29723	142	3	0	4	28536	136	3	0	4
			3	29638	141	3	0	4	29489	140	3	0	4	28303	135	3	0	4
			4F	30623	146	3	0	4	30592	146	3	0	4	20889	142	3	0	4
			4W	29286	139	3	0	5	29140	139	3	0	5	27970	133	3	0	5
			5QW	30047	143	5	0	4	29896	142	5	0	4	28694	137	5	0	4
	235	235.0	2	32960	140	3	0	4	32796	140	3	0	4	31475	134	3	0	4
			3	32701	139	3	0	4	32537	138	3	0	4	31229	133	3	0	4
			4F	31582	134	3	0	4	31550	134	3	0	4	30825	131	3	0	4
			4W	32313	138	3	0	5	32152	137	3	0	5	30861	131	3	0	5
			5QW	33153	141	5	0	4	32987	140	5	0	4	31660	135	5	0	4
255	261.2	2	36216	142	4	0	5	36035	141	4	0	5	34585	136	4	0	5	
		3	35932	141	3	0	4	35752	140	3	0	4	34314	135	3	0	4	
		4F	34254	131	3	0	4	34219	131	3	0	4	33432	128	3	0	4	
		4W	35505	139	4	0	5	35329	139	4	0	5	33910	133	4	0	5	
		5QW	36428	143	5	0	5	36246	142	5	0	5	34788	136	5	0	5	

¹ VAC input Lumen values are from photometric test performed in accordance with IESNA LM-79-08. Data is considered to be representative of the configurations. Actual performance may differ as a result of end-user environment and application.

SLING Micro Strike

AREA/SITE/ROAD LIGHTER

ELECTRICAL DATA

Family	Nominal Wattage	Input Voltage (Volts)	Current (AMPS)	System Power (Watts)
SLING (ASL1)	25	120	0.21	25.4
		208	0.12	
		240	0.11	
		277	0.09	
		347	0.07	
		480	0.05	
	39	120	0.32	38
		208	0.18	
		240	0.16	
		277	0.14	
		347	0.11	
		480	0.08	
	50	120	0.41	49.7
		208	0.24	
		240	0.21	
		277	0.18	
		347	0.14	
		480	0.10	
	70	120	0.57	68.4
		208	0.33	
		240	0.29	
		277	0.25	
		347	0.20	
		480	0.14	
	100	120	0.73	88
		208	0.42	
		240	0.37	
		277	0.32	
		347	0.25	
		480	0.18	
115	120	0.91	109.7	
	208	0.53		
	240	0.46		
	277	0.40		
	347	0.32		
	480	0.23		
135	120	1.11	133.3	
	208	0.64		
	240	0.56		
	277	0.48		
	347	0.38		
	480	0.28		

SLING (ASL2) Next Page

SLING Micro Strike

AREA/SITE/ROAD LIGHTER

ELECTRICAL DATA (CONT'D)

Family	Nominal Wattage	Input Voltage (Volts)	Current (AMPS)	System Power (Watts)
SLING (ASL2)	145	120	1.19	143.0
		208	0.69	
		240	0.60	
		277	0.52	
		347	0.41	
		480	0.30	
	170	120	1.40	168.0
		208	0.81	
		240	0.70	
		277	0.61	
		347	0.48	
		480	0.35	
	185	120	1.54	185.0
		208	0.89	
		240	0.77	
		277	0.67	
		347	0.53	
		480	0.39	
	210	120	1.75	210.0
		208	1.01	
		240	0.88	
		277	0.76	
		347	0.61	
		480	0.44	
	235	120	1.96	235.0
		208	1.13	
		240	0.98	
		277	0.85	
		347	0.68	
		480	0.49	
255	120	2.18	261.2	
	208	1.26		
	240	1.09		
	277	0.94		
	347	0.75		
	480	0.54		

SLING Micro Strike

AREA/SITE/ROAD LIGHTER

PROJECTED LUMEN MAINTENANCE

Ambient Temperature	OPERATING HOURS					
	0	25,000	TM-21-11' L96 60,000	50,000	100,000	L70 (Hours)
25°C / 77°F	1.00	0.97	0.96	0.95	0.91	408,000
40°C / 104°F	0.99	0.96	0.95	0.94	0.89	356,000

1. Projected per IESNA TM-21-11 (* Cree XP-L, 2100mA, 105°C Ts, 6,000hrs)

LUMINAIRE AMBIENT TEMPERATURE FACTOR (LATF)

Ambient Temperature		Lumen Multiplier
0° C	32° F	1.06
10° C	50° F	1.03
20° C	68° F	1.01
25° C	77° F	1.00
30° C	86° F	0.99
40° C	104° F	0.97

Use these factors to determine relative lumen output for average ambient temperatures from 0-40°C (32-104°F).

DIMENSIONS

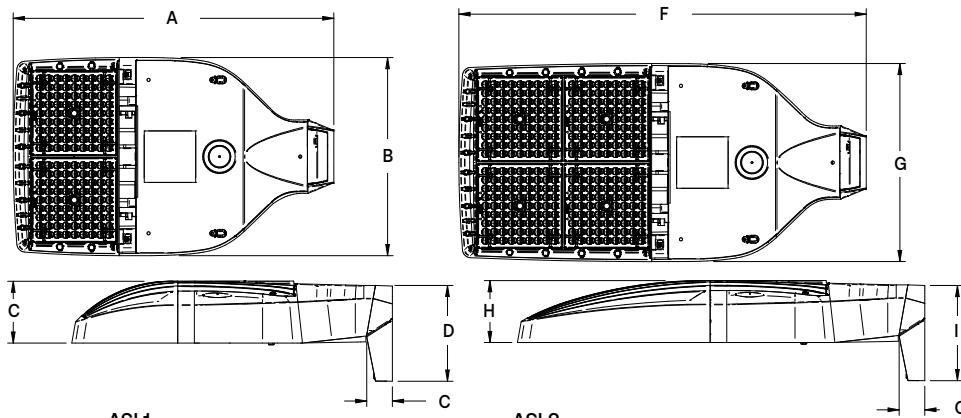

Weight	
ASL1	14.47 lbs (6.56 kgs)
ASL2	17.47 lbs (7.92 kgs)

ASL1					ASL2								
A	B	C	D	E	F	G	H	I	ASL1 EPA@0°	ASL2 EPA@0°	ASL1 w/ HSS	ASL2 w/ HSS	
18.9"	11.7"	3.7"	5.65"	1.5"	24.0"	11.7"	3.7"	5.62"	.46 ft. ²	.56 ft. ²	.73 ft. ²	1.01 ft. ²	
480mm	297mm	94mm	144mm	38mm	610mm	297mm	94mm	143mm	.043 m ²	.052 m ²	.068 m ²	.094 m ²	

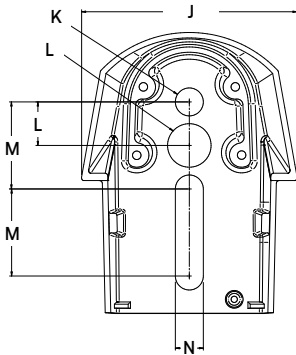

J	K	L	M	N
4.33"	.562"	.875"	1.75"	.562"
480mm	297mm	94mm	610mm	297mm

PHOTOMETRY

The following diagrams represent the general distribution options offered for this product. For detailed information on specific product configurations, see [website photometric test reports](#).

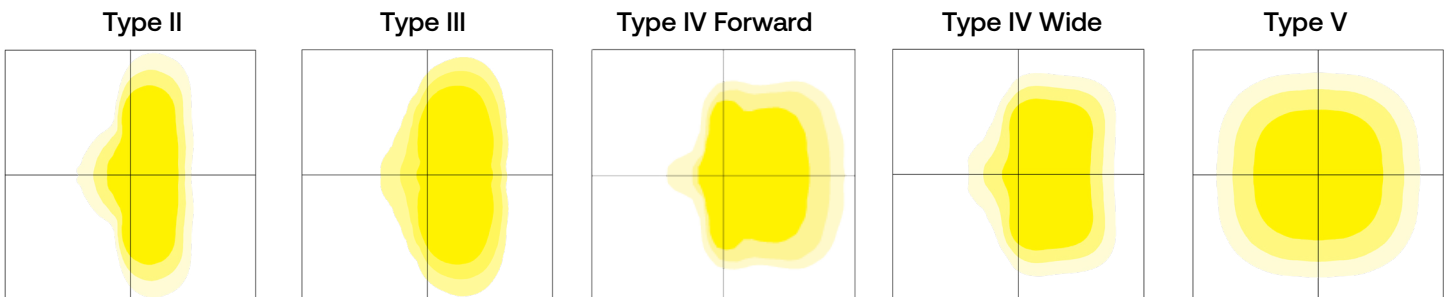

SLING Micro Strike

AREA/SITE/ROAD LIGHTER

ADDITIONAL INFORMATION (CONT'D)

OCCUPANCY SENSOR

- Individual fixture control
- Dims product when space is not occupied



7-PIN RECEPTACLE

- Compatible with 3-pin, 5-pin or 7-pin photocontrols
- Turns fixture on when sun sets, off when sun rises
- For use with a variety of control platforms

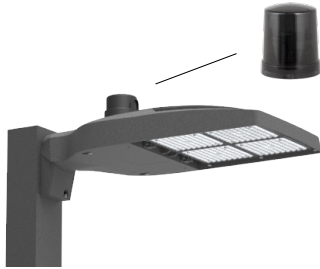

MOUNTING

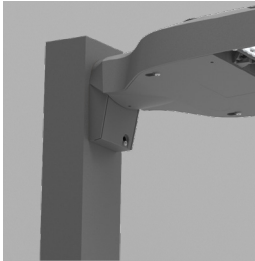

Arm Mount – Fixture ships with integral arm for ease of installation. Compatible with Outdoor S2 drill pattern.

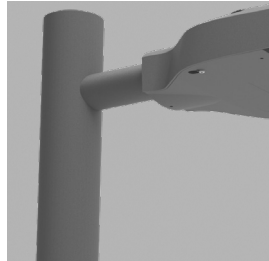

MAF – Fits 2-3/8" OD arms Roadway applications.

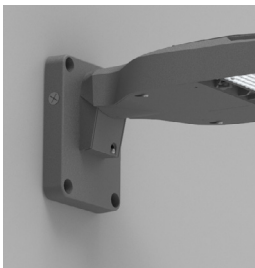

Wall Mount – Wall mount bracket designed for building mount applications.

S2 DRILL PATTERN

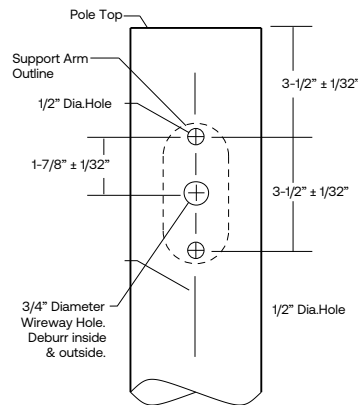

SLING Micro Strike

AREA/SITE/ROAD LIGHTER

ADDITIONAL INFORMATION (CONT'D)

MOUNTING (CONT'D)

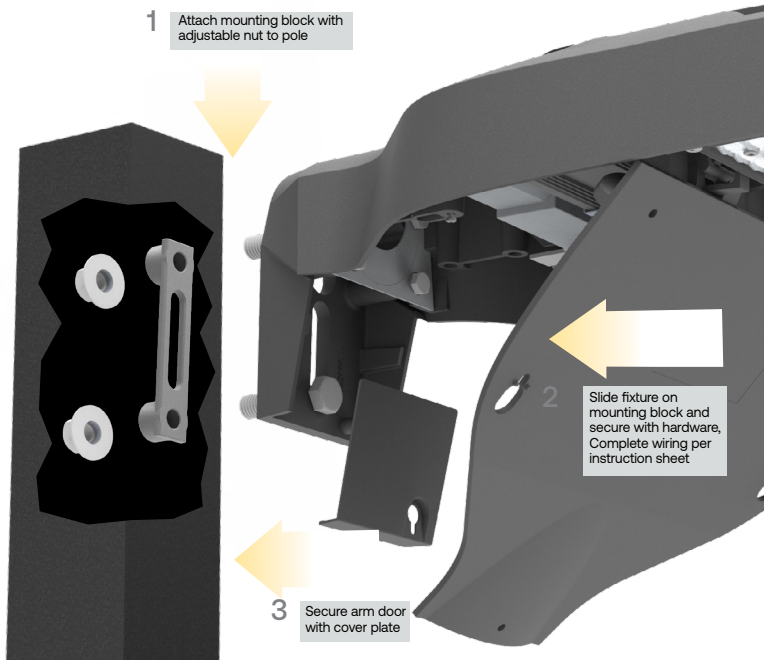

Square Arm Mounting Block –Arm mount block for ease of installation. Compatible with S2 drill patterns from 2.5" to 4.5"

ACCESSORY

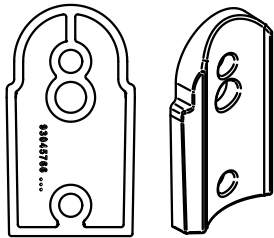

ROUND POLE ADAPTER



WB-AREA-XX

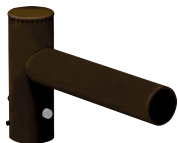

SPOKE BRACKET (single arm shown)
Horizontal round arm tenon adapters for use with MAF mounting type or accessory kit. Reference SBH Spoke Pole Top Brackets for ordering information.

SLING Micro Strike

AREA/SITE/ROAD LIGHTER

ADDITIONAL INFORMATION (CONT'D)

CONFIGURATIONS

ASLx HSS-90-B-xx

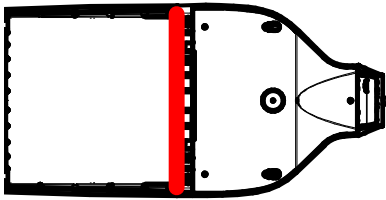

ASLx HSS-270-BSS-xx

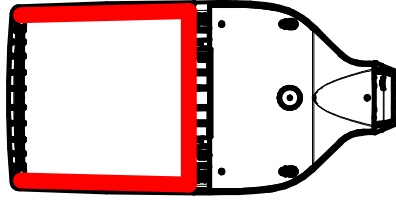

ASLx HSS-360-xx

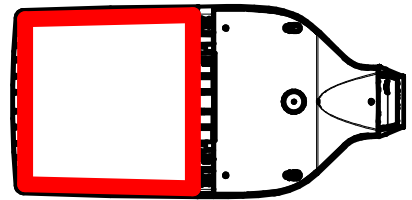

ASLx HSS-90-F-xx

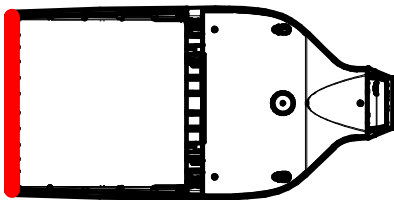

ASLx HSS-270-FSS-xx

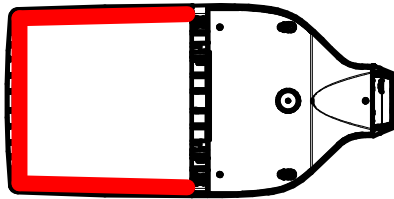

ASLx HSS-90-S-xx

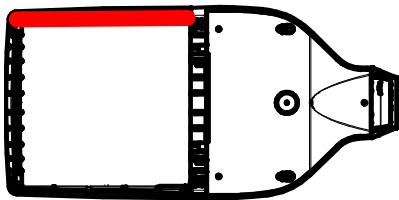

ASLx HSS-270-FSB-xx

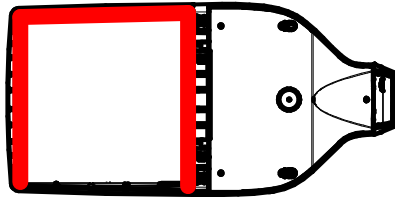

ASLx HSS-90-S-xx

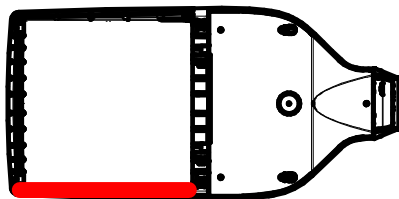

ASLx HSS-270-FSB-xx

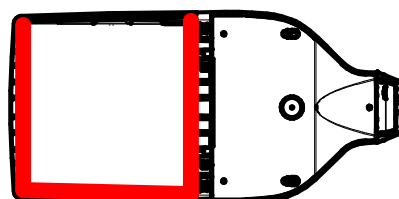

SLING Series

SLENDER WALLPACK

tradeSELECT®

FEATURES

- Two sizes for a variety of applications
- Ranges from 21W to 80W with up to 8000 lumens
- SG1 Series replaces from 100W-150W HID; SG2 Series replaces from 150W-250W HID
- Comfort lens available as an option or accessory provides glare control and enhanced uniformity
- Knuckle and trunnion accessory mounting kits available for flood applications
- IP65 and certified to UL 1598 for use in wet locations up to 40°C ambient



SPECIFICATIONS

HOUSING

- Rugged die-cast aluminum housing with corrosion resistant powder coat finish
- Heating dissipating fins provide superior thermal performance extending the life of the electronic components
- Impact resistant tempered glass offers zero uplight
- Comfort lens available as an option or accessory to reduce glare (7-10% lumen reduction) and provide better uniformity

OPTICS

- 3000K, 4000K and 5000K CCT nominal with 70 CRI
- Smaller SG1 housing has 2 LEDs, larger SG2 housing has 3 LEDs

INSTALLATION

- Side hinge allows for easy installation and wiring
- Side movement avoids damage to the lens and helps prevent injury common in drop down hinge designs
- Mounts to 4" junction box and includes a gasket to help seal electrical connections
- Four 1/2" threaded conduits hubs for surface conduit provided

ELECTRICAL

- 120-277V, 50/60Hz electronic drivers
- 347V and 480V available in large SG2 housing
- 10KA surge protection included

OPTIONS/CONTROLS

- Button photocontrol for dusk to dawn energy savings. Stock versions include 120V-277V PC with a cover which provides a choice to engage photocontrol or not. PC is installed in top hub
- Occupancy sensor available for on/off and dimming control in larger SG2 housing
- Battery backup options available in larger SG2 housing rated for either 0° C or -30° C. Performance exceeds NEC requirement providing 1 fc minimum over 10'x10' at 11' mounting height

CERTIFICATIONS

- Listed to UL1598 for use in wet location, listed for -40°C to 40°C applications
- Complies with IDA standards with zero uplight for 3000K and warmer CCT's
- IP65

WARRANTY

- 5 year warranty

KEY DATA	
Lumen Range	2263-8079
Wattage Range	21-80
Efficacy Range (LPW)	101-113
Weights lbs. (kg)	4.3-11 (2.0-5.0)

SLING SERIES

SLENDER WALLPACK

DATE:	LOCATION:
TYPE:	PROJECT:
CATALOG #:	

ORDERING GUIDE

Example: SG1-20-3K7-FT-UNV-DBT-PCU-CS

CATALOG #

ORDERING INFORMATION

Housing	CCT/CRI	Distribution	Voltage	Color/Finish	Control Options	Options
SG1-10 Size 1, 10W	3K7 3000K, 70 CRI	FT Fwd Throw	UNV 120V-277V	BLT Black Matte Textured	PCU Universal Button Photocontrol (120-277V)	CS Comfort Lens
SG1-20 Size 1, 20W	4K7 4000K, 70 CRI		120 120V	BLS Black Gloss Smooth	SCP ^{1,2,3} Occupancy Sensor Programmable (Dim)	E ^{1,2} Battery 0°C
SG1-30 Size 1, 30W	5K7 5000K, 70 CRI		277 277V	DBT Dark Bronze Matte Textured	Specify MTG HT for OCC Sensor	EH ^{1,2} Battery w/ heater -20°
SG1-40 Size 1, 40W			UHV 347V-480V	DBS Dark Brone Gloss Smooth	8F Up to 8'	
SG2-50 Size 2, 50W				GTT Graphite Matte Textured	20F Up to 20'	
SG2-80 Size 2, 80W				LGS Light Grey Gloss Smooth		
				PSS Platinum Silver Smooth		
				WHT White Matte Textured		
				WHS White Gloss Smooth		
				VGT Verde Green Textured		
				Color Option		
				CC Custom Color		

Notes:

- 1 Available in SG2 only, UHV available in SG2-50 only
- 2 Sensor controls & battery backup can not be used with flood accessory or kit or for inverted/up mounting, 120-227V only for SCO/SCP, 120 or 277 only for SWP, SWPM, E & EH
- 3 Must order minimum of one remote control to program dimming settings, 0-10V fully adjustable dimming with automatic daylight calibration and different time delay settings, 120-277V only

STOCK ORDERING INFORMATION

Catalog Number	CCT/CRI	Wattage	Mounting Height	Color	Color	Delivered Lumens	LPW	Weight lbs. (kg)
SG1-10-PCU	5000K/70	11W	8-12ft	120-277V	Dark Bronze	1349	122	4.3 (2.0)
SG1-10-4K-PCU	4000K/70	11W	8-12ft	120-277V	Dark Bronze	1424	129	4.3 (2.0)
SG1-20-PCU	5000K/70	21W	8-12ft	120-277V	Dark Bronze	2263	108	4.3 (2.0)
SG1-20-4K-PCU	4000K/70	21W	8-12ft	120-277V	Dark Bronze	2310	110	4.3 (2.0)
SG1-30-PCU	5000K/70	29W	10-15ft	120-277V	Dark Bronze	3270	113	4.3 (2.0)
SG1-30-4K-PCU	4000K/70	29W	10-15ft	120-277V	Dark Bronze	3060	105	4.3 (2.0)
SG1-40-PCU	5000K/70	38W	10-15ft	120-277V	Dark Bronze	4008	105	4.3 (2.0)
SG1-40-4K-PCU	4000K/70	38W	10-15ft	120-277V	Dark Bronze	4070	106	4.3 (2.0)
SG2-50-PCU	5000K/70	51W	12-18ft	120-277V	Dark Bronze	5548	110	11 (5.0)
SG2-50-4K-PCU	4000K/70	51W	12-18ft	120-277V	Dark Bronze	5526	109	11 (5.0)
SG2-80-PCU	5000K/70	80W	15-25ft	120-277V	Dark Bronze	8061	101	11 (5.0)
SG2-80-4K-PCU	4000K/70	80W	15-25ft	120-277V	Dark Bronze	8079	101	11 (5.0)

SLING SERIES

SLENDER WALLPACK

DATE: _____ LOCATION: _____

TYPE: _____ PROJECT: _____

CATALOG #: _____

ORDERING GUIDE

OPTIONS AND ACCESSORIES

	Catalog Number	Description	Weight lbs. (kg)
<input type="checkbox"/>	SG1-YOKE	SG1 Series Yoke/Floodlight mount kit, includes visor	2.0 (1.0)
<input type="checkbox"/>	SG1-KNUCKLE	SG1 Series Knuckle/Floodlight mount kit, includes visor	2.0 (1.0)
<input type="checkbox"/>	SG2-YOKE	SG2 Series Yoke/Floodlight mount kit, includes visor	2.0 (1.0)
<input type="checkbox"/>	SG2-KNUCKLE	SG2 Series Knuckle/Floodlight mount kit, includes visor	2.0 (1.0)
<input type="checkbox"/>	SCP-REMOTE*	Remote control for SCP option. Order at least one per project to program and control fixtures	1 (.45)

PERFORMANCE DATA

Description	# of LEDs	Drive Current	System Watts	5K (5000K NOMINAL 70 CRI)					4K (4000K NOMINAL 70 CRI)					3K (3000K NOMINAL 80 CRI)				
				Lumens	LPW	B	U	G	Lumens	LPW	B	U	G	Lumens	LPW	B	U	G
SG1-10	2	140mA	11	1349	122	1	0	0	1424	129	1	0	0	1003	91	1	0	0
SG1-20	2	250mA	21	2449	115	1	0	0	2310	110	1	0	0	2054	95	1	0	0
SG1-30	2	350mA	29	3332	117	2	0	0	3060	106	1	0	0	2913	100	1	0	0
SG-40	2	450mA	38	4008	105	2	0	0	4070	106	2	0	0	3845	100	2	0	0
SG2-50-UHV	3	350mA	44	4633	106	2	0	0	4609	105	2	0	0	3895	90	2	0	0
SG2-50	3	415mA	51	5548	109	2	0	0	5526	107	2	0	0	4700	92	2	0	0
SG2-80	3	650mA	80	7851	98	2	0	1	8079	103	2	0	1	6721	86	2	0	1

*347 and 480 VAC input Lumen values are from photometric test performed in accordance with IESNA LM-79-08. Data is considered to be representative of the configurations shown. Actual performance may differ as a result of end-user environment application and inherent performance balances of the electrical components.

ELECTRICAL DATA

Catalog number	# of Drivers	Input Voltage	Current (AMPS)	System Power
SG1-10	1	120	0.09	11.0
	1	277	0.04	11.0
SG1-20	1	120	0.18	21.0
	1	277	0.08	21.0
SG1-30	1	120	0.24	28.9
	1	277	0.10	28.9
SG2-40	1	120	0.32	38.3
	1	277	0.14	38.3
SG-50-UHV	1	347	0.13	43.5
	1	480	0.18	43.5
SG2-50	1	120	0.42	50.6
	1	277	0.18	50.6
SG2-80	1	120	0.68	79.8
	1	277	0.29	79.8

PROJECTED LUMEN MAINTENANCE

Ambient Temperature	OPERATING HOURS					
	0	25,000	50,000	TM-21-11' L96 60,000	100,000	L70 (Hours)
25°C / 77°F	1.00	0.98	0.97	0.96	0.95	>791,000
40°C / 104°F	0.99	0.98	0.96	0.96	0.94	>635,000

1. Projected per IESNA TM-21-11 * (Nichia 219B, 700mA, 85°C Ts, 10,000hrs) Data references the extrapolated performance projections for the base model in a 40°C ambient, based on 10,000 hours of LED testing per IESNA LM-80-08

SLING SERIES

SLENDER WALLPACK

LUMINAIRE AMBIENT TEMPERATURE FACTOR (LATF)

Ambient Temperature		Lumen Multiplier
0° C	32° F	1.02
10° C	50° F	1.01
20° C	68° F	1.00
25° C	77° F	1.00
30° C	86° F	1.00
40° C	104° F	0.99
50° C	122° F	0.96

Use these factors to determine relative lumen output for average ambient temperatures from 0-40°C (32-104°F).

DIMENSIONS

SG1

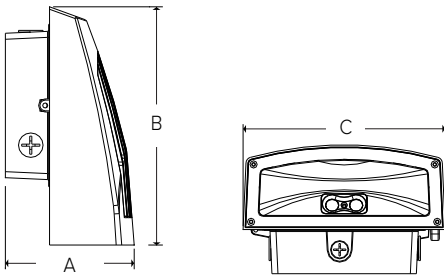

A	B	C	Weight
4.19" (107mm)	7.80" (198mm)	6.61" (168mm)	4.4lbs (2kg)

SG2

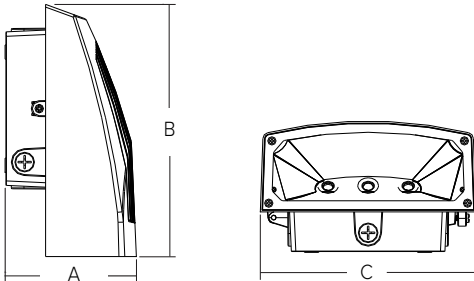

A	B	C	Weight
5.80" (147mm)	11.14" (283mm)	9.52" (242mm)	11lbs (5kg)

SG2 with occupancy sensor and battery options

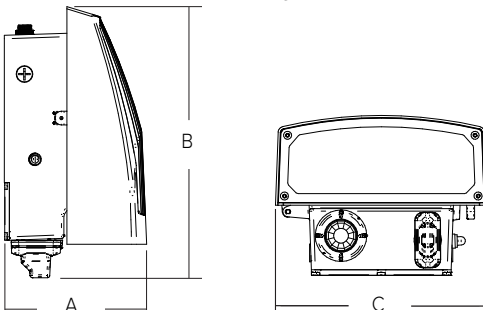

A	B	C	Weight
7.26" (184mm)	13.64" (342mm)	9.52" (242mm)	11lbs (5kg)

SLING SERIES
SLENDER WALLPACK

PHOTOMETRY

SG1-10-4K7

LUMINAIRE DATA

Description	4000 Kelvin, 70 CRI
Distribution Type	Forward Throw
Delivered Lumens	1424
Watts	11.4
Efficacy	125
Mounting	Wall

ZONAL LUMEN SUMMARY

Zone	Lumens	% Luminaire
Downward Street Side	996.6	70.0
Downward House Side	427.8	30.0
Downward Total	1424.4	100.0
Upward Street Side	0.0	0.0
Upward House Side	0.0	0.0
Upward Total	0.0	0.0
Total Flux	1424.4	100.0

ISOMETRIC FOOTCANDLE

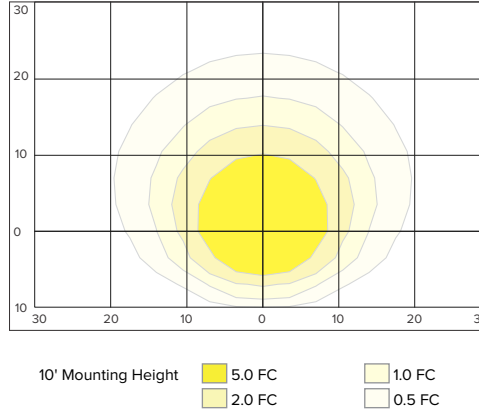

SG1-20-4K7

LUMINAIRE DATA

Description	4000 Kelvin, 70 CRI
Distribution Type	Forward Throw
Delivered Lumens	2310
Watts	20.9
Efficacy	111
Mounting	Wall

ZONAL LUMEN SUMMARY

Zone	Lumens	% Luminaire
Downward Street Side	1618	70.0
Downward House Side	692.1	30
Downward Total	2310	100.0
Upward Street Side	0.0	0.0
Upward House Side	0.0	0.0
Upward Total	0.0	0.0
Total Flux	2310.3	100.0

ISOMETRIC FOOTCANDLE

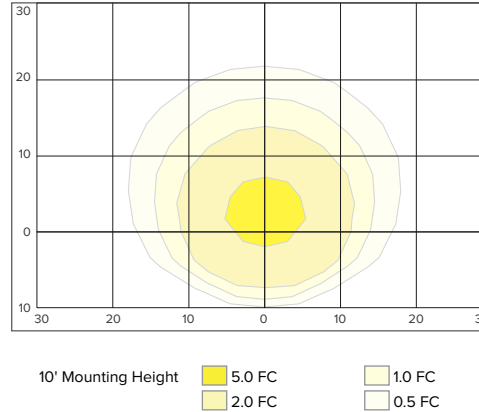

SG1-30

LUMINAIRE DATA

Description	4000 Kelvin, 70 CRI
Distribution Type	Forward Throw
Delivered Lumens	3060
Watts	29.1
Efficacy	105
Mounting	Wall

ZONAL LUMEN SUMMARY

Zone	Lumens	% Luminaire
Downward Street Side	2619.4	70.9
Downward House Side	890.4	29.1
Downward Total	3059.8	100.0
Upward Street Side	0.0	0.0
Upward House Side	0.0	0.0
Upward Total	0.0	0.0
Total Flux	3059.8	100.0

ISOMETRIC FOOTCANDLE

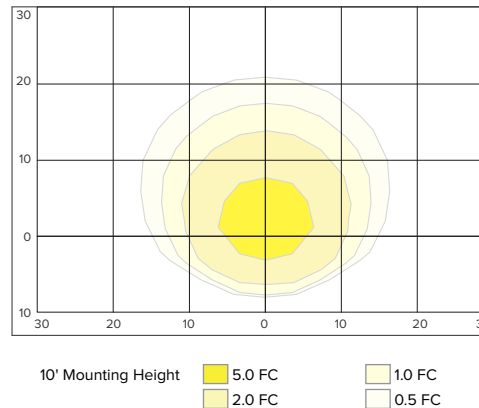

SLING SERIES

SLENDER WALLPACK

PHOTOMETRY

SG1-40-4K7

LUMINAIRE DATA

Description	4000 Kelvin, 70 CRI
Distribution Type	Forward Throw
Delivered Lumens	4070
Watts	38.1
Efficacy	107
Mounting	Wall

ZONAL LUMEN SUMMARY

Zone	Lumens	% Luminaire
Downward Street Side	2857.7	70.2
Downward House Side	1215.5	29.8
Downward Total	4070.2	100.0
Upward Street Side	0.0	0.0
Upward House Side	0.0	0.0
Upward Total	0.0	0.0
Total Flux	4070.2	100.0

ISOMETRIC FOOTCANDLE

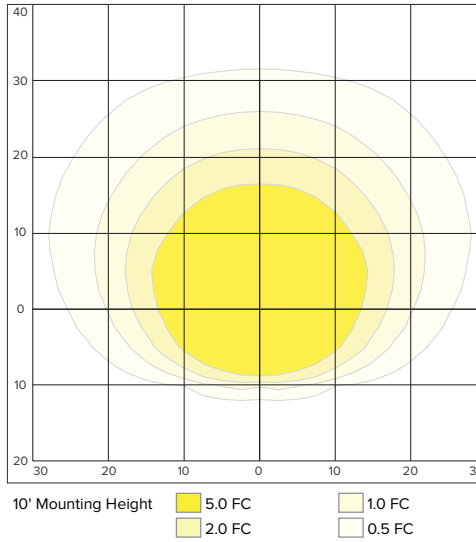

SG2-50-4K7

LUMINAIRE DATA

Description	4000 Kelvin, 70 CRI
Distribution Type	Forward Throw
Delivered Lumens	5525.7
Watts	51.7
Efficacy	107
Mounting	Wall

ZONAL LUMEN SUMMARY

Zone	Lumens	% Luminaire
Downward Street Side	4611.8	83.5
Downward House Side	913.9	16.5
Downward Total	5525.7	100.0
Upward Street Side	0.0	0.0
Upward House Side	0.0	0.0
Upward Total	0.0	0.0
Total Flux	5525.7	100.0

ISOMETRIC FOOTCANDLE

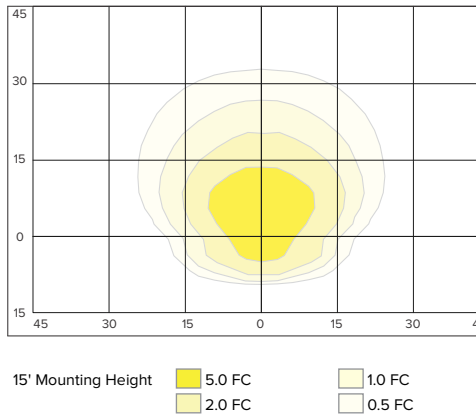

SG2-80-4K7

LUMINAIRE DATA

Description	4000 Kelvin, 70 CRI
Distribution Type	Forward Throw
Delivered Lumens	8453
Watts	78.5
Efficacy	108
Mounting	Wall

ZONAL LUMEN SUMMARY

Zone	Lumens	% Luminaire
Downward Street Side	6677.7	79.0
Downward House Side	1775.5	21.0
Downward Total	8453.2	100.0
Upward Street Side	0.0	0.0
Upward House Side	0.0	0.0
Upward Total	0.0	0.0
Total Flux	8453.2	100.0

ISOMETRIC FOOTCANDLE

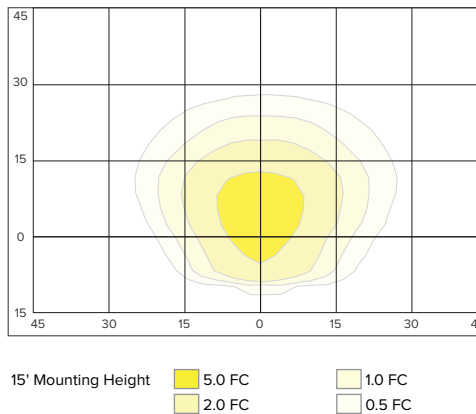

SLING SERIES
SLENDER WALLPACK

DATE: _____ LOCATION: _____

TYPE: _____ PROJECT: _____



CATALOG #: _____

ADDITIONAL INFORMATION

Shipping Information

Catalog Number	G.W(kg)/ CTN	Carton Dimensions			Carton Qty. per Master Pack	Pallet Qty.
		Length Inch (cm)	Width Inch (cm)	Height Inch (cm)		
SG1	4.35lbs (2kg)	9.5 (24)	8.25 (21)	5.25 (13)	6	98
SG2	11lbs (5kg)	14 (36)	11.5 (29)	8 (20)	2	64

Accessories and Services

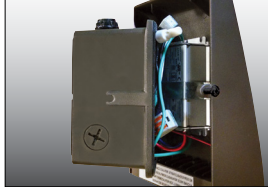
Visor	Mounting Options	Photocontrol	Hinged Housing Door
			
Visor accessory included with mounting accessory kits	Flood mounting accessories - 1/2" threaded knuckle or yoke (includes grommet and 3' SO cord)	Photocontrol option available for energy-saving dusk-to-dawn operation	Side hinged for easy installation and wiring access, single screw secures housing closure