

Casey's

**SIGN
PACKET**

JACOB CLARK

jacob.clark@caseys.com

Naperville, IL #6533

1290 S Route 59

New Store

11-23-22

Building & Wall Signs (U4 Flat Roof)

Sign #	Sign	Type	Location	Illumination	Dimensions				Boxed Area Ft ²
					Height	Width	Bottom	Top	
1	"Casey's"	Surface	Building Front	Internal	6'-0"	15' 4-1/4"	12' 7"	18' 7"	92.12
2	Snap Frame	Advertising	Building Front	N/A	3' 0"	8' 0"	3' 4"	6' 8-1/2"	24
3	Snap Frame	Advertising	Building Front	N/A	3' 8"	2' 4"	2' 10"	6' 10-1/2"	8.56
Total									124.68

Canopy

Sign #	Sign	Type	Location	Illumination	Dimensions				Boxed Area Ft ²
					Height	Width	Bottom	Top	
4	"Casey's"	Surface	Canopy Front	Internal	2' 5"	6' 2-3/16"	17' 3"	19' 8"	14.95
4	"Casey's"	Surface	Canopy Side	Internal	2' 5"	6' 2-3/16"	17' 3"	19' 8"	14.95
4	"Casey's"	Surface	Canopy Side	Internal	2' 5"	6' 2-3/16"	17' 3"	19' 8"	14.95
3	Snap Frame	Advertising	Canopy Column	N/A	3' 8"	2' 4"	3' 0"	7' 0-1/2"	8.56
3	Snap Frame	Advertising	Canopy Column	N/A	3' 8"	2' 4"	3' 0"	7' 0-1/2"	8.56
3	Snap Frame	Advertising	Canopy Column	N/A	3' 8"	2' 4"	3' 0"	7' 0-1/2"	8.56
3	Snap Frame	Advertising	Canopy Column	N/A	3' 8"	2' 4"	3' 0"	7' 0-1/2"	8.56
3	Snap Frame	Advertising	Canopy Column	N/A	3' 8"	2' 4"	3' 0"	7' 0-1/2"	8.56
3	Snap Frame	Advertising	Canopy Column	N/A	3' 8"	2' 4"	3' 0"	7' 0-1/2"	8.56
3	Snap Frame	Advertising	Canopy Column	N/A	3' 8"	2' 4"	3' 0"	7' 0-1/2"	8.56
3	Snap Frame	Advertising	Canopy Column	N/A	3' 8"	2' 4"	3' 0"	7' 0-1/2"	8.56
Total									113.33

Brick Monument Sign (10' OAH)

Sign #	Sign	Type	Location	Illumination	Dimensions				Boxed Area Ft ²
					Height	Width	Bottom	Top	
5a	Price Sign	Freestanding	Street	Internal	4' 4"	9' 9"	0' 11"	5' 3"	42.25
	Product Flag	Freestanding	Street	N/A	1' 6"	2' 6"	3' 0"	4' 6"	3.75
Total									46

Brick Monument Sign (10' OAH)

Sign #	Sign	Type	Location	Illumination	Dimensions				Boxed Area Ft ²
					Height	Width	Bottom	Top	
5b	Price Sign	Freestanding	Street	Internal	4' 4"	9' 9"	0' 11"	5' 3"	42.25
	Product Flag	Freestanding	Street	N/A	1' 6"	2' 6"	3' 0"	4' 6"	3.75
Total									46

SIGNS 1, 2, 3

1



3

WEST ELEVATION

2



SOUTH ELEVATION

N.T.S.



NAPERVILLE, IL #6533

C-STORE

**DRAWN BY:
J. CLARK**

**DATE:
10-24-22**

SIGNS 3, 4

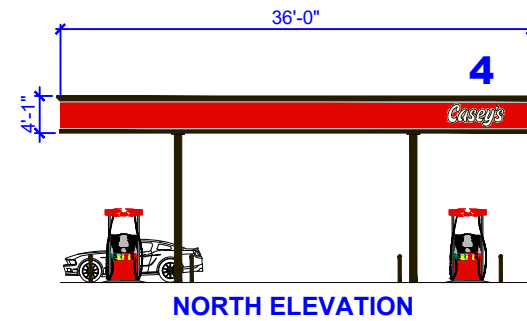
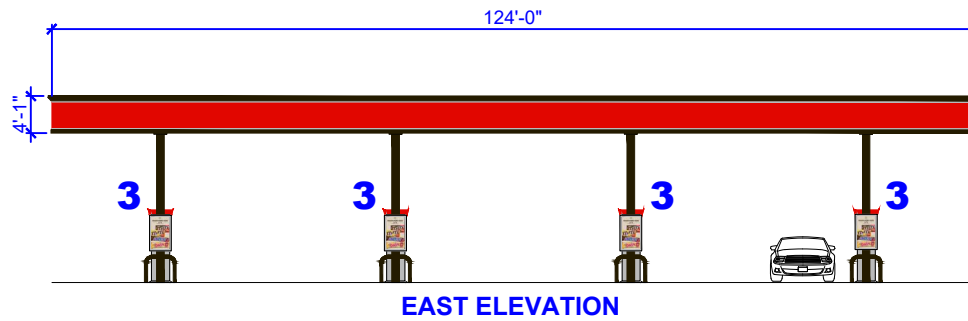
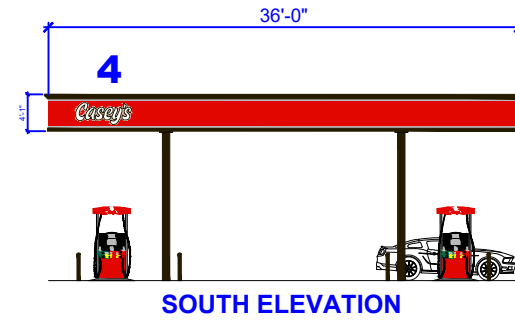
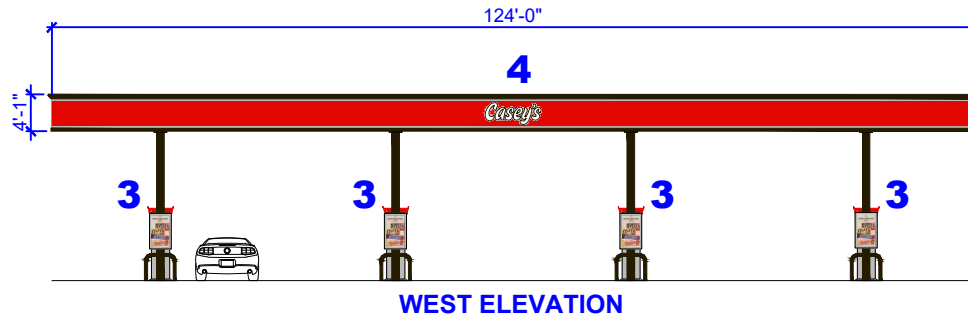

N.T.S.



NAPERVILLE, IL #6533

FUEL CANOPY

DRAWN BY:
J. CLARK

DATE:
07-15-21

Brick Monument Sign (10' OAH)

SIGN 6

Sign #	Sign	Type	Location	Illumination	Dimensions				
					Height	Width	Bottom	Top	Area Ft ²
6	Price Sign	Freestanding	Street	Internal	4' 4"	9' 9"	0' 11"	5' 3"	42.25
	Product Flag	Freestanding	Street	N/A	1' 6"	2' 6"	3' 0"	4' 6"	3.75
Total								46	

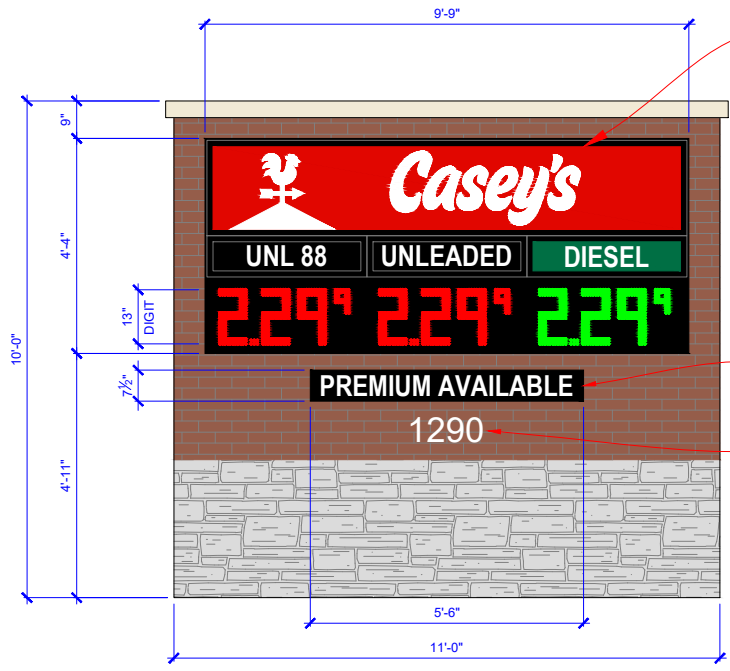

ALL BACKGROUNDS TO BE OPAQUE
ONLY COPY CAN ILLUMINATE

QTY. 2 MONUMENT SIGNS

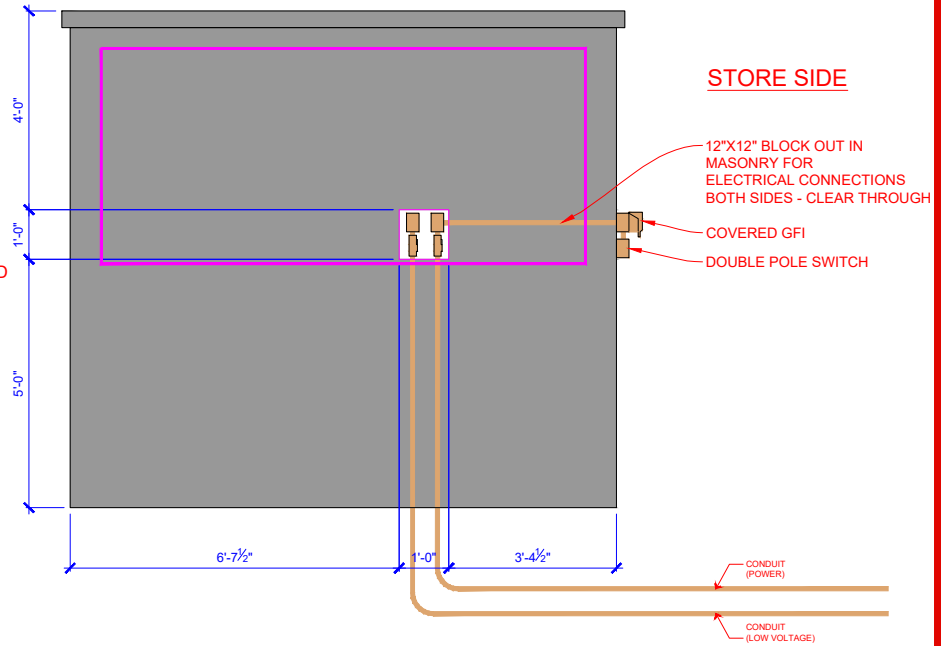

NON-ILLUMINATED PANEL
6" ADDRESS #S
WHITE, METALLIC

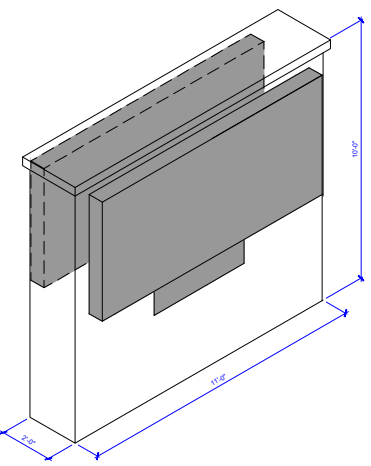

FREESTANDING SIGN LANDSCAPING:

REFER TO LANDSCAPING PLAN BY KIMLEY-HORN.

A LANDSCAPED AREA LOCATED AROUND THE BASE OF THE GROUND SIGN EQUAL TO ONE SQUARE FOOT FOR EACH ONE SQUARE FOOT OF MONUMENT SIGN AREA IS REQUIRED FOR ALL MONUMENT SIGNS. THE LANDSCAPED AREA SHALL CONTAIN WELL MAINTAINED MATERIAL INCLUDING LIVING LANDSCAPE MATERIALS, ARCHITECTURAL STONES, WATER FEATURES OR OTHER BEAUTIFICATION MEASURES PLACED THROUGHOUT THE REQUIRED LANDSCAPE AREA. IT IS THE RESPONSIBILITY OF THE PROPERTY OWNER TO ENSURE THAT LANDSCAPING IS INSTALLED WITHIN SIX (6) MONTHS FROM THE INSTALLATION OF THE MONUMENT SIGN.

PRICER NOTES:

- 13" RED AND GREEN LED DIGITS
- STATIC LABELS, NON-INTERCHANGEABLE
- DIESEL ON THE RIGHT, BOTH SIDES

OTHER NOTES

- PRODUCT "TAG" IS NON-ILLUMINATED
- CABINET IS BLACK IN COLOR
- 300' WIRELESS KEYPAD RANGE

NAPERVILLE, IL #6533

MONUMENT SIGN

DRAWN BY:
J. CLARK

DATE:
11-23-22

Channel Letters

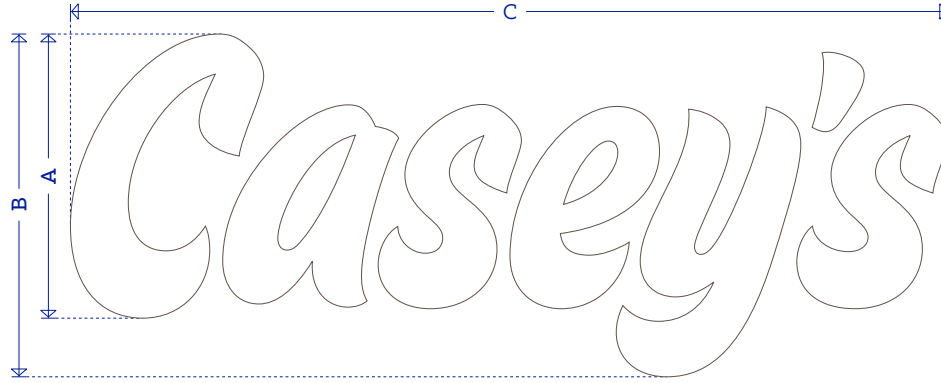

Channel Letters | not to scale

Letter "C" Height A	Overall Height B	Overall Length C	Return Depth	Boxed Square Footage
59 11/16"	6'-0"	15'-4 1/4"	5"	92.12



end view

CHANNEL LETTER SPECIFICATIONS:

- > Return: .040" aluminum returns
- > Trim Cap: 1" bronze
- > Backs: .063" aluminum
- > Exterior finish: pre-finished #313 bronze
- > Interior finish: pre-finished white
- > Illumination: GE 7100K white LED's
- > Lumen output: 300 - 400 lumens/sq. ft.
- > Face material: 7328 white acrylic
- > Mounting Type: flush

Item # 600120

Horizontal
Pizza Sign Frame

Dimensions

- Graphic Insert Size: 96.0"W x 36.0"H
- Visual Opening: 94.35"W x 34.35"W
- Outside Dimension: 97.75" x 37.75"
- Insert Thickness: .125" - .250
- Insert Backer: 4MM = .1575" Fluted Plastic
- Material: Anodized Aluminum, Satin Silver

Frame Profile

Insert Thickness for FFST 1.25"

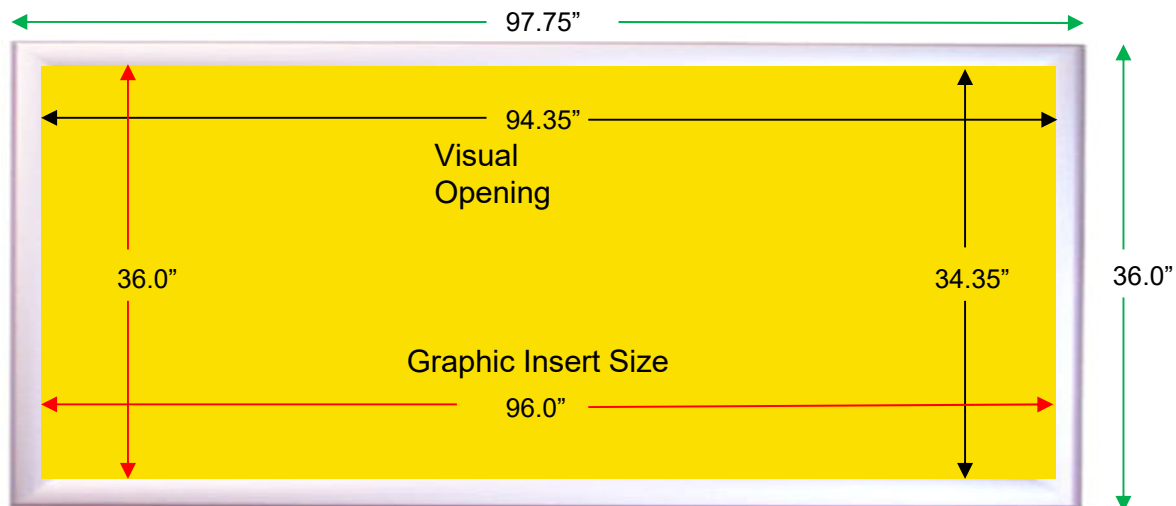
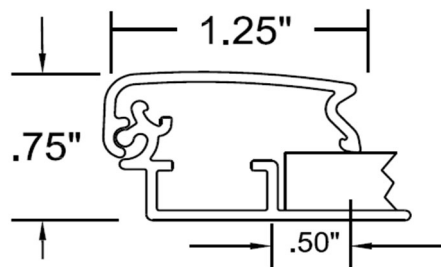

Item # 601600

Vertical
Wall Sign Frame

Dimensions

- Graphic Insert Size: 44.0" x 28.0"
- Visual Opening: 42.35" x 26.35"
- Outside Dimension: 45.75" x 29.75"
- Insert Thickness: .125" - .250"
- Insert Backer: 4MM = .1575" Fluted Plastic
- Material: Anodized Aluminum, Satin Silver

Frame Profile

Insert Thickness for FFST 1.25"

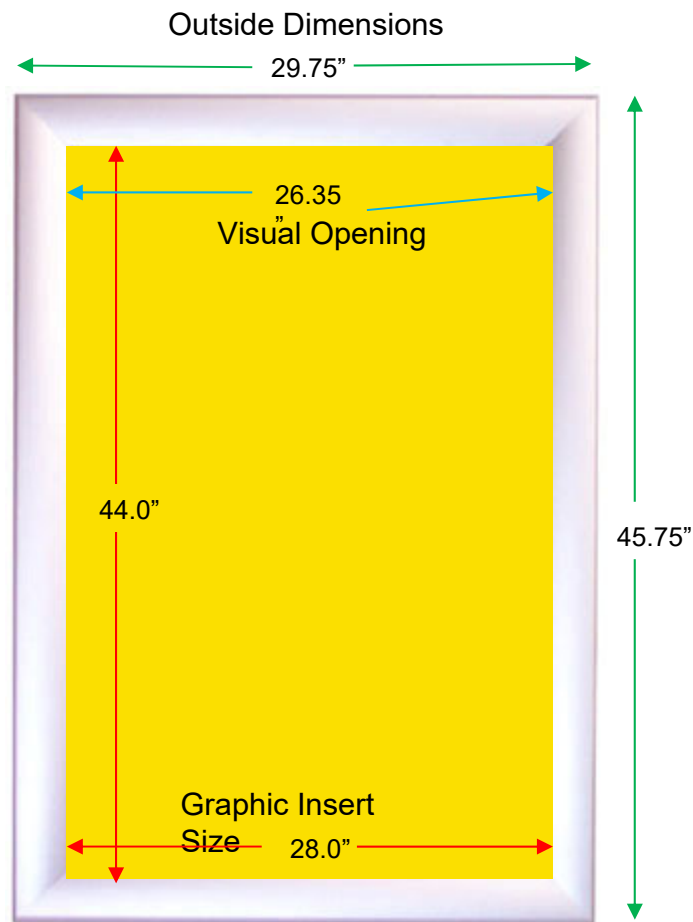
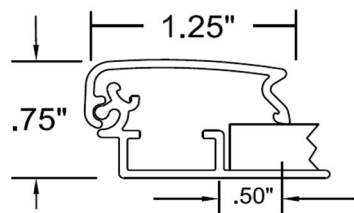

Channel Letters

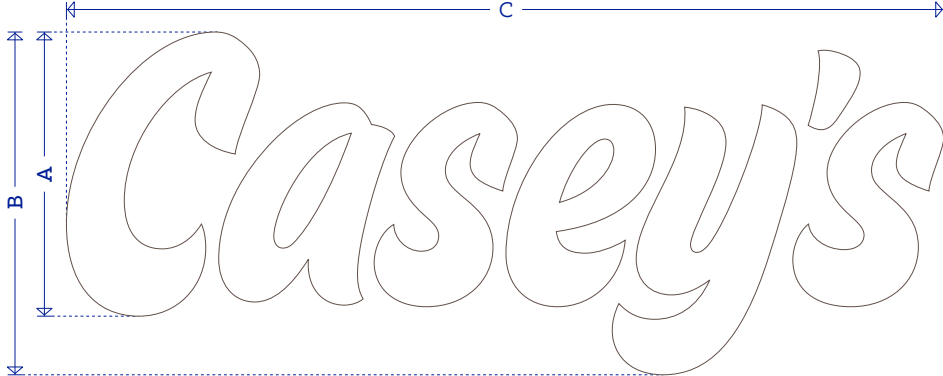

Channel Letters | not to scale

Letter "C" Height A	Overall Height B	Overall Length C	Return Depth	Boxed Square Footage
24 1/16"	2'-5"	6'-2 3/16"	3"	14.95

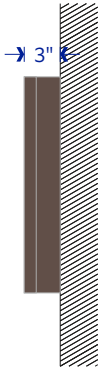

end view

CHANNEL LETTER SPECIFICATIONS:

- > Return: .040" aluminum returns
 - > Trim Cap: 1" bronze
 - > Backs: .063" aluminum
 - > Exterior finish: pre-finished #313 bronze
 - > Interior finish: pre-finished white
 - > Illumination: GE 7100K white LED's
 - > Lumen output: 300 - 400 lumens/sq. ft.
 - > Face material: 7328 white acrylic
 - > Mounting Type: flush
- * 2'-5" (overall height) channel letters to be dry rated for building installations and wet rated for canopy installations.



316 S. 6th Street,
St. Joseph, MO 64501 800. 821. 9013

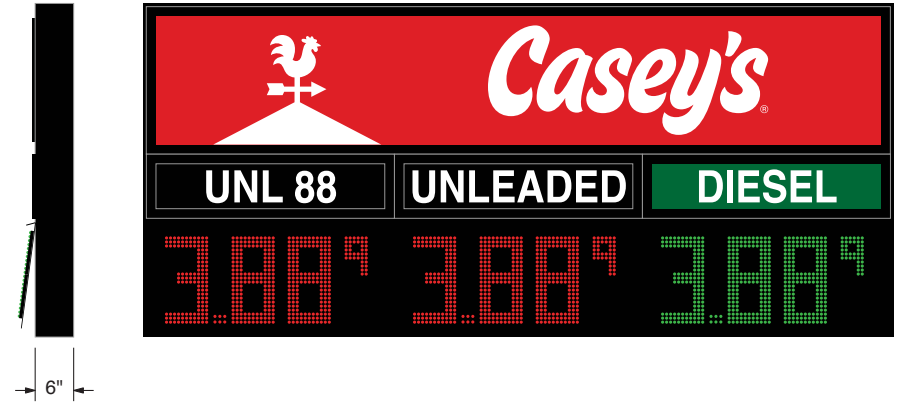
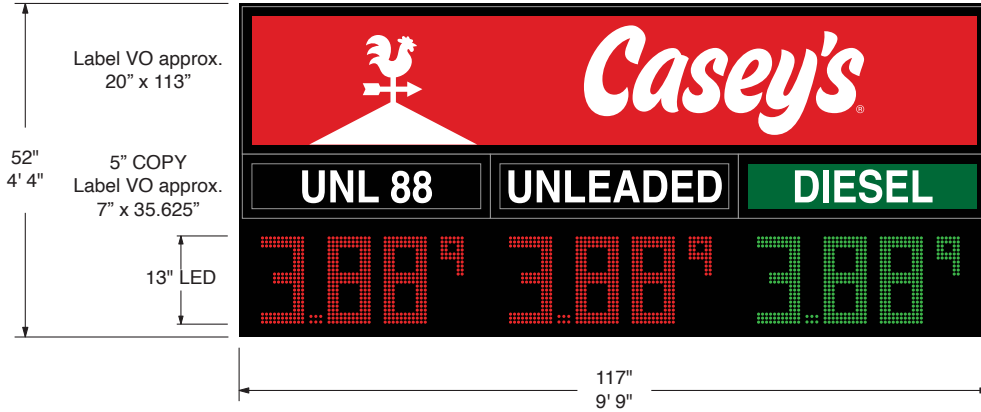

Client	Install Location	Sales	SIGN 5	
Casey's	TBA	John Waller 816-387-4248 johnw@sunshine.us.com		
Client Approval:		Date:		

Red Background will be Opaque
White Copy and Logo will be Translucent

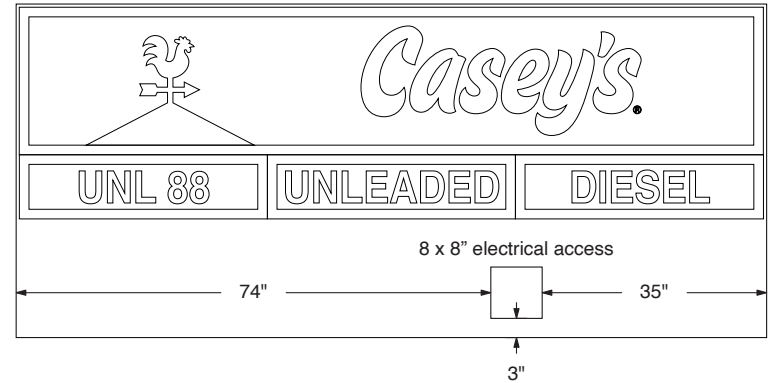
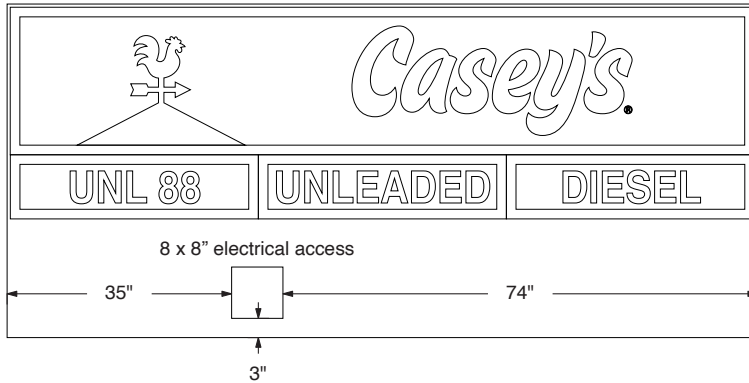

Electrical access back to back



Cabinet Specs	Label Specs	Other	
Digit Size & Color: 13" red/red/green LED	LED Backlit Label Panel -	* Label colors for representation only	This original drawing is provided as part of a planned project and is not to be exhibited, copied or reproduced without the written permission of Sunshine Electronic Display Corporation or its authorized agent. All installation details are suggested only. All signs must be installed in accordance with NATIONAL, STATE, ELECTRICAL AND BUILDING CODES. Sunshine Electronic Display Corporation has no responsibility for wind loads, installations or electrical circuits. These are the sole responsibility of the Buyer/user. * Actual LED size and configuration may vary
Overall Cabinet Size: 4'4"h x 9'9"w x 6"d	Label Font: Helvetica Bold	* 42.3 sq ft	
Cabinet Color: Black	Label Panel Color: Opaque Black	PMS 2347 C	
Single or Double Face: Double	Label Type Color: White		
Build type: Split cabinets	'DIESEL' Label Panel Color: 3M 3630-26 Green		 UL File Number: E340294 CCN: UXYT  ETL LISTED CONFORMS TO UL STD 48 UL STD 1433 CERTIFIED TO CAN/CSA STD C22.2 NO. 207

SOUTH ROUTE 59

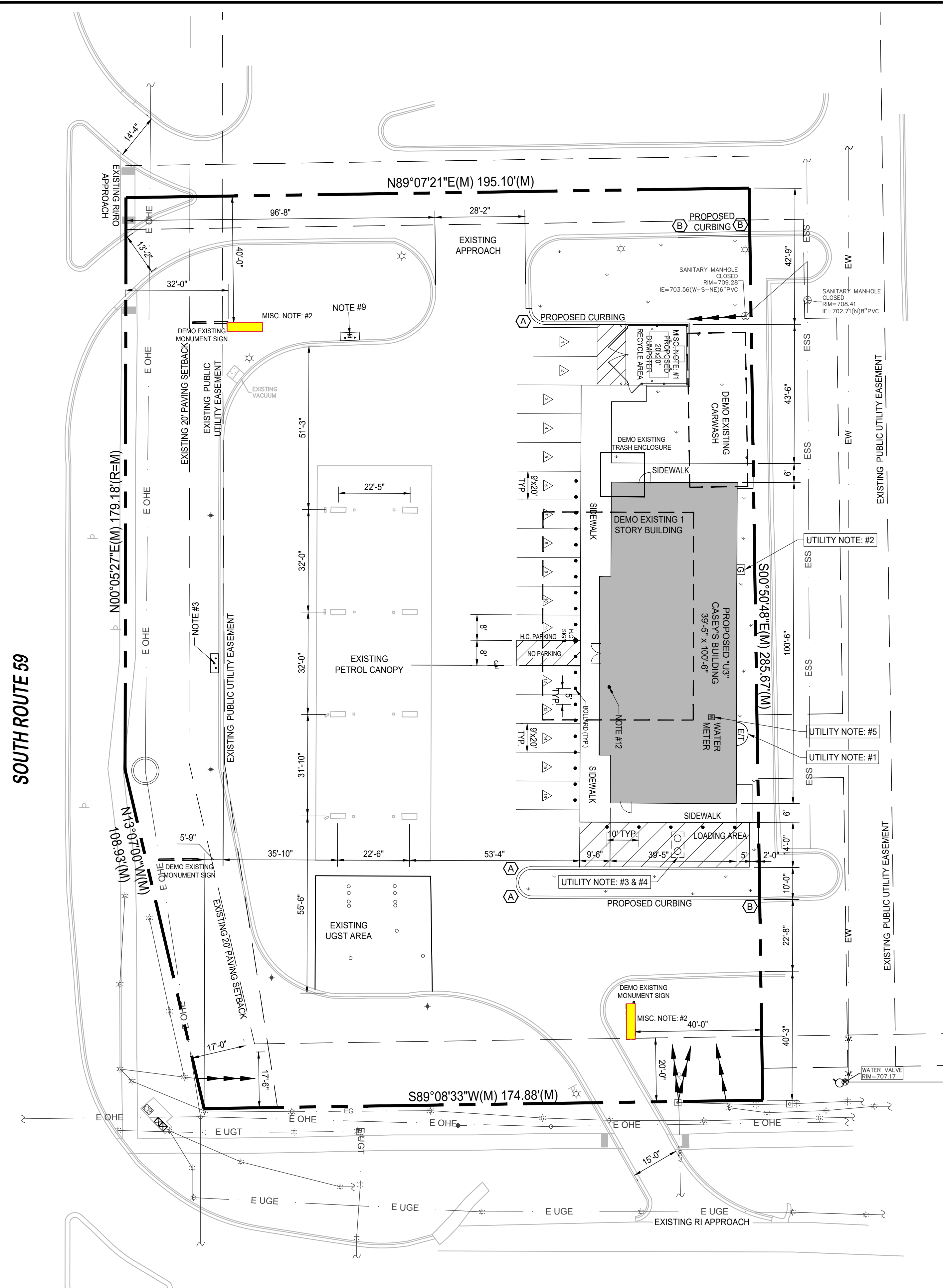

75TH STREET

TRUE PLAN NORTH NORTH **A1** Site Layout Plan 1" = 20'

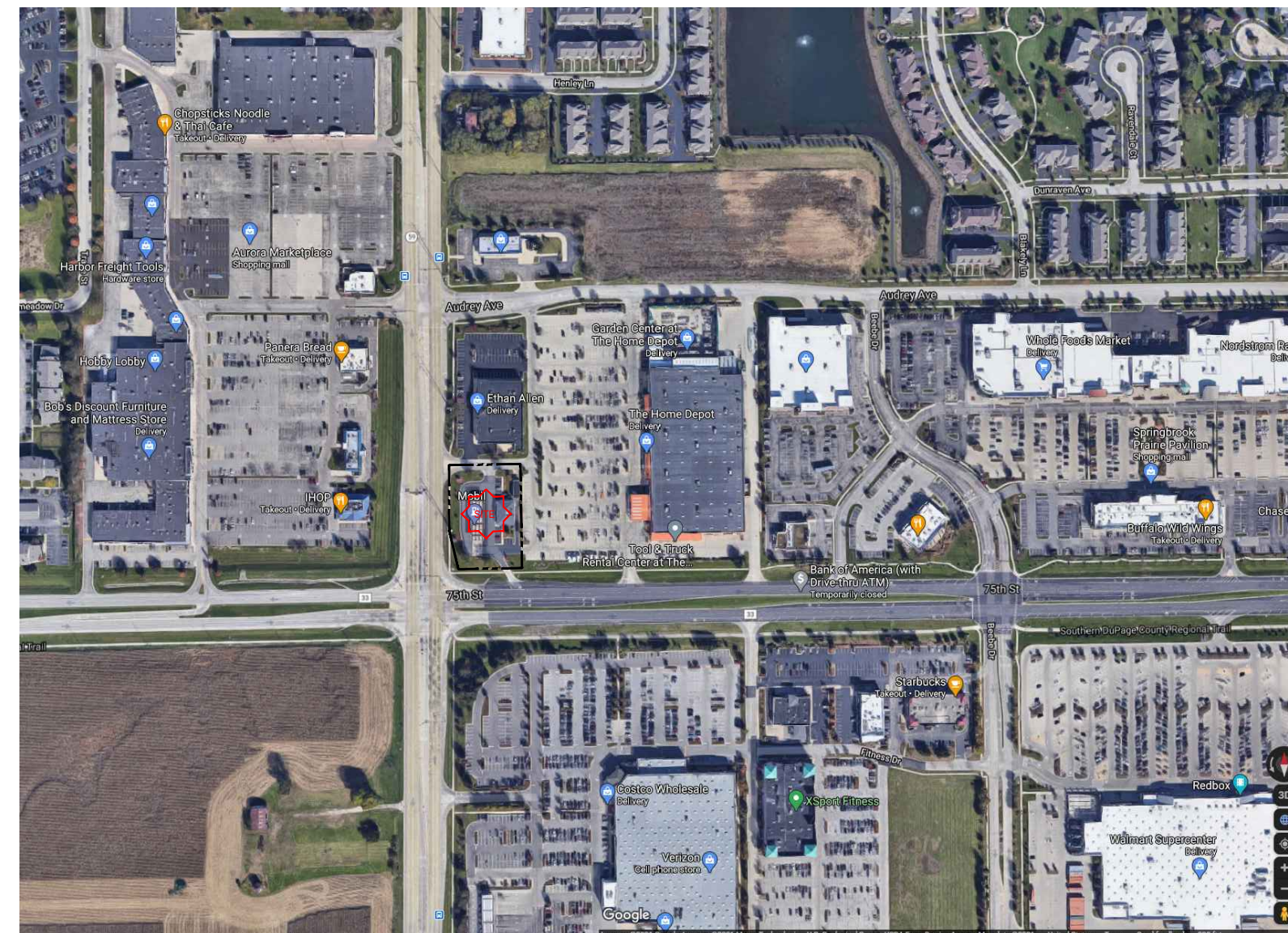

VICINITY MAP NTS